



FJ110LB2

OWNER'S MANUAL

This manual should be considered a permanent part of the motorcycle and should remain with the motorcycle when resold or otherwise transferred to a new owner or operator. The manual contains important safety information and instructions which should be read carefully before operating the motorcycle.

IMPORTANT

BREAK-IN (RUNNING-IN) INFORMATION FOR YOUR MOTORCYCLE

The first 1600 km are the most important in the life of your motorcycle. Proper break-in operation during this time will help ensure maximum life and performance from your new motorcycle. Suzuki parts are manufactured of high quality materials, and machined parts are finished to close tolerances. Proper break-in operation allows the machined surfaces to polish each other and mate smoothly.

Motorcycle reliability and performance depend on special care and restraint exercised during the break-in period. It is especially important that you avoid operating the engine in a manner which could expose the engine parts to excessive heat.

Please refer to the BREAK-IN (RUNNING-IN) section for specific break-in recommendations.

For further inquiries & concerns, feel free to contact us at:

SUZUKI PHILIPPINES, INCORPORATED
CUSTOMER CARE DEPARTMENT
126 Progress Avenue, Carmelray Industrial Park 1,
Carmelton, Canlubang, Calamba City 4028, Laguna



▲ WARNING/▲ CAUTION/NOTICE/NOTE

Please read this manual and follow its instructions carefully. To emphasize special information, the symbol ▲ and the words **WARNING**, **CAUTION**, **NOTICE** and **NOTE** have special meanings. Pay particular attention to messages highlighted by these signal words:

▲ WARNING

Indicates a potential hazard that could result in death or serious injury.

▲ CAUTION

Indicates a potential hazard that could result in minor or moderate injury.

NOTICE

Indicates a potential hazard that could result in vehicle or equipment damage.

NOTE: Indicates special information to make maintenance easier or instructions clearer.

FOREWORD

Motorcycling is one of the most exhilarating sports and to ensure your riding enjoyment, you should become thoroughly familiar with the information presented in this Owner's Manual before riding the motorcycle.

The proper care and maintenance that your motorcycle requires is outlined in this manual. By following these instructions explicitly you will ensure a long trouble free operating life for your motorcycle. Your authorized Suzuki dealer has experienced technicians that are trained to provide your machine with the best possible service with the right tools and equipment.

All information, illustrations and specifications contained in this manual are based on the latest product information available at the time of publication. Due to improvements or other changes, there may be some discrepancies between information in this manual and your motorcycle. Suzuki reserves the right to make changes at any time.

SUZUKI PHILIPPINES, INCORPORATED



TABLE OF CONTENTS

CONSUMER INFORMATION	1
CONTROLS	2
FUEL AND ENGINE OIL RECOMMENDATIONS	3
BREAK-IN (RUNNING-IN) AND INSPECTION BEFORE RIDING	4
RIDING TIPS	5
INSPECTION AND MAINTENANCE	6
TROUBLESHOOTING	7
STORAGE PROCEDURE AND MOTORCYCLE CLEANING	8
SPECIFICATIONS	
INDEX	

CONSUMER INFORMATION

ACCESSORY USE AND MOTORCYCLE LOADING	1-2
SAFE RIDING RECOMMENDATION FOR MOTORCYCLE RIDERS	1-5
LABELS	1-7
MODIFICATION	1-7
SERIAL NUMBER LOCATION	1-8

CONSUMER INFORMATION

ACCESSORY USE AND MOTORCYCLE LOADING

ACCESSORY USE

The addition of unsuitable accessories can lead to unsafe operating conditions. It is not possible for Suzuki to test each accessory on the market or combinations of all the available accessories; however, your dealer can assist you in selecting quality accessories and installing them correctly. Use extreme caution when selecting and installing the accessories on your motorcycle and consult your Suzuki dealer if you have any questions.

WARNING

Improper installation of accessories or modification of the motorcycle may cause changes in handling which could lead to an accident.

Never use improper accessories, and make sure that any accessories that are used are properly installed. All parts and accessories added to the motorcycle should be genuine Suzuki parts or their equivalent designed for use on this motorcycle. Install and use them according to their instructions. If you have any questions, contact your Suzuki dealer.

ACCESSORY INSTALLATION GUIDELINES

- Install aerodynamic-affecting accessories, such as a fairing, windshield, backrests, saddlebags, and travel trunks, as low as possible, as close to the motorcycle and as near the center of gravity as is feasible. Check that the mounting brackets and other attachment hardware are rigidly mounted.
 - Inspect for proper ground clearance and bank angle. Inspect that the accessory does not interfere with the operation of the suspension, steering or other control operations.
 - Accessories fitted to the handlebars or the front fork area can create serious stability problems. This extra weight will cause the motorcycle to be less responsive to your steering control. The weight may also cause oscillations in the front end and lead to instability problems. Accessories added to the handlebars or front fork of the machine should be as light as possible and kept to a minimum.
- Select an accessory which does not limit the freedom of rider movement.
 - Select an electrical accessory which does not exceed the motorcycle's electrical system capacity. Severe overloads may damage the wiring harness or create hazardous situations.
 - Do not pull a trailer or sidecar. This motorcycle is not designed to pull a trailer or sidecar.

LOADING GUIDELINES

WARNING

Overloading or improper loading can cause loss of motorcycle control and an accident.

Follow loading guidelines in this manual.

This motorcycle is primarily intended to carry small items when you are not riding with a passenger. Follow the loading guidelines below:

- Balance the load between the left and right side of the motorcycle and fasten it securely.
- Keep cargo weight low and as close to the center of the motorcycle as possible.
- Do not attach large or heavy items to the handlebars, front forks or rear fender.

- Check that both tires are properly inflated to the specified tire pressure for your loading conditions. Refer to page 6-47.
- Improperly loading your motorcycle can reduce your ability to balance and steer the motorcycle. You should ride at reduced speeds, less than 130 km/h, when carrying cargo or when accessories are installed.

SAFE RIDING RECOMMENDATION FOR MOTORCYCLE RIDERS

Motorcycle riding is great fun and an exciting sport. Motorcycle riding also requires that some extra precautions be taken to ensure the safety of the rider and passenger. These precautions are:

WEAR A HELMET

Motorcycle safety equipment starts with a quality helmet. One of the most serious injuries that can happen is a head injury. ALWAYS wear a properly approved helmet. You should also wear suitable eye protection.

RIDING APPAREL

Loose, fancy clothing can be uncomfortable and unsafe when riding your motorcycle. Choose good quality motorcycle riding apparel when riding your motorcycle.

INSPECTION BEFORE RIDING

Review thoroughly the instructions in the “INSPECTION BEFORE RIDING” section of this manual. Do not forget to perform an entire safety inspection to ensure the safety of the rider and its passenger.

FAMILIARIZE YOURSELF WITH THE MOTORCYCLE

Your riding skill and your mechanical knowledge form the foundation for safe riding practices. We suggest that you practice riding your motorcycle in non-traffic situation without obstacles until you are thoroughly familiar with your machine and its controls. Remember practice makes perfect.

KNOW YOUR LIMITS

Ride within the boundaries of your own skill at all times. Knowing these limits and staying within them will help you to avoid accidents.

BE EXTRA SAFETY CONSCIOUS ON BAD WEATHER DAYS

Riding on bad weather days, especially wet ones, requires extra caution. Braking distances double on a rainy day. Stay off the painted surface marks, manhole covers and greasy appearing areas as they can be especially slippery. Use extreme caution at railway crossings and on metal gratings and bridges. Whenever in doubt about road condition, slow down!

RIDE DEFENSIVELY

The most common type of motorcycle accident occurs when a car traveling towards a motorcycle turns round corner in front of the motorcyclist. Ride defensively. Wise motorcyclist uses a strategy of assuming they are invisible to other drivers, even in broad daylight. Wear bright, reflecting clothing. Turn on the headlight and taillight every time even on a bright, sunny day to attract driver's attention. Do not ride in another driver's blind spot.

LABELS

Read and follow all the labels on the motorcycle. Make sure you understand all of the labels. Do not remove any labels from the motorcycle.

MODIFICATION

Modification of the motorcycle, or removal of original equipment may render the vehicle unsafe or illegal. Obey all applicable equipment regulations in your area.

SERIAL NUMBER LOCATION

The frame and/or engine serial numbers are used to register the motorcycle. They are also used to assist your dealer when ordering parts or referring to special service information.

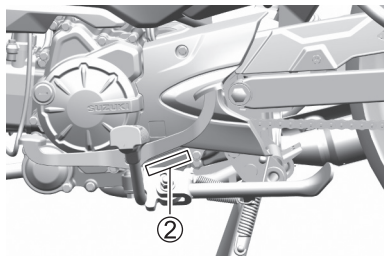
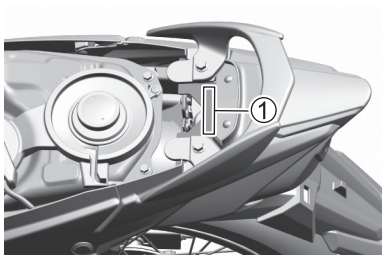

The frame number ① is stamped on the rear handle plate. The engine serial number ② is stamped on the crankcase assembly.

Please write down the numbers in the box provided below for your future reference.

Frame number:

Engine number:

CONTROLS

LOCATION OF PARTS	2-2
KEY	2-5
IGNITION SWITCH	2-6
INSTRUMENT PANEL	2-8
LEFT HANDLEBAR	2-10
RIGHT HANDLEBAR	2-12
FUEL TANK CAP	2-13
KICK STARTER LEVER	2-15
GEARSHIFT LEVER	2-16
REAR BRAKE PEDAL	2-17
SEAT LOCK AND HELMET HOLDERS	2-17
LUGGAGE BOX	2-19
STANDS	2-20

CONTROLS

LOCATION OF PARTS

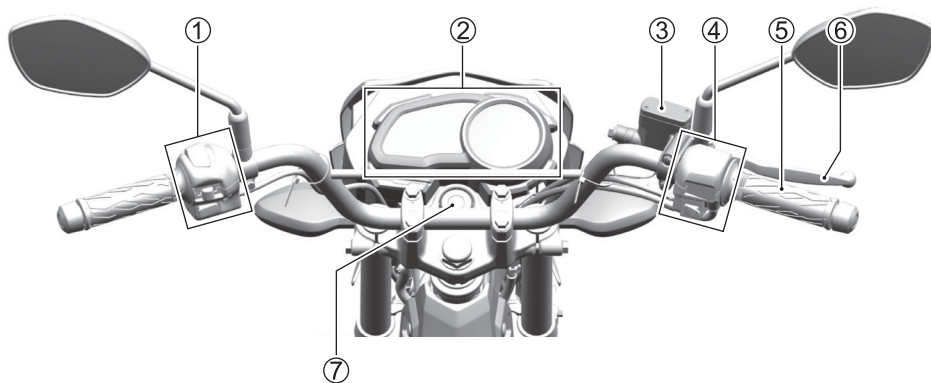

- ① Left handlebar switches
- ② Instrument panel
- ③ Front brake fluid reservoir
- ④ Right handlebar switches

- ⑤ Throttle grip
- ⑥ Front brake lever
- ⑦ Ignition switch

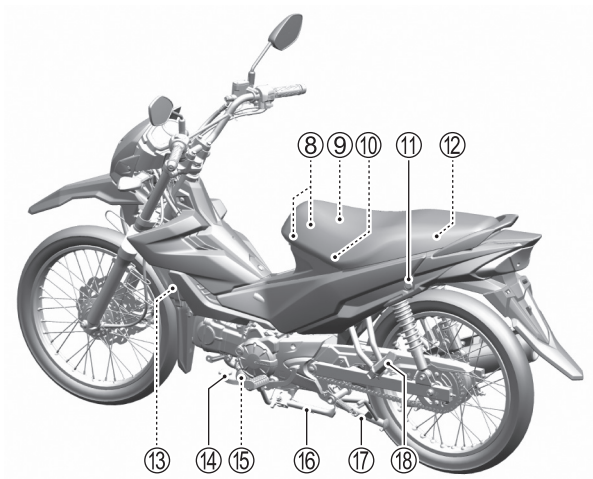

⑧ Helmet holders

⑨ Tools

⑩ Luggage box (Battery and fuse)

⑪ Seat lock

⑫ Fuel tank cap

⑬ Air cleaner

⑭ Gearshift lever

⑮ Engine oil filter

⑯ Side stand

⑰ Center stand

⑱ Passenger footrests

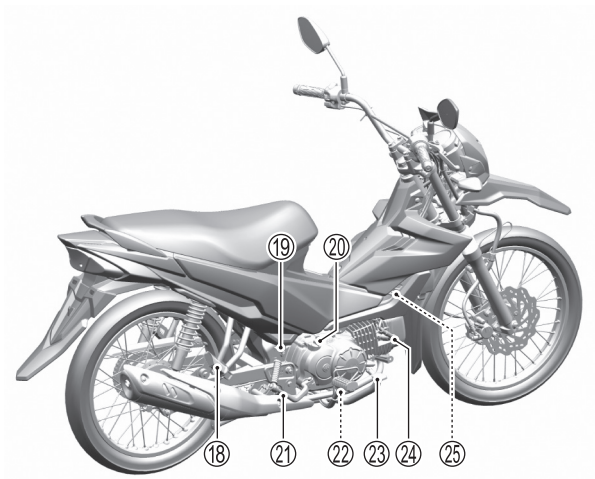

- ⑱ Rear brake light switch
- ⑳ Engine oil filler cap
- ㉑ Kick starter lever
- ㉒ Engine oil drain plug
- ㉓ Rear brake pedal
- ㉔ Spark plug

㉕ Air screw

KEY

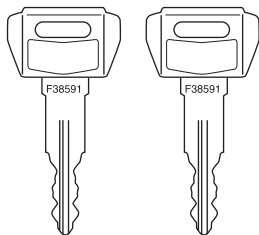

This motorcycle comes equipped with a pair of identical ignition keys. Keep the spare keys in a safe place.

IGNITION SWITCH

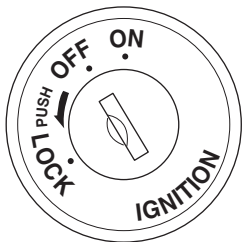

The ignition switch has 3 positions:

“OFF” Position

All electrical circuits are cut off. The engine will not start. The key can be removed.

“ON” Position

The ignition circuit is completed and the engine can now be started. The key cannot be removed from the ignition switch in this position.

“LOCK” Position

To lock the steering, turn the handlebar all the way to the left. Push the key in and turn it to the “LOCK” position and remove the key. All electrical circuits are cut off.

NOTE:

- *Move the handlebar to the right and left, to make sure that the steering has been locked securely.*
- *When it cannot be locked easily, turn the key to the “LOCK” position, moving the handlebar slightly to the right.*

WARNING

Turning the ignition switch to the “LOCK” position while the motorcycle is moving can be hazardous. Moving the motorcycle while the steering is locked can be hazardous. You could lose your balance and fall, or you could drop the motorcycle.

Stop the motorcycle and place it on the center stand before locking the steering. Never attempt to move the motorcycle when the steering is locked.

WARNING

If the motorcycle falls down due to a slip or collision, unexpected damage to the motorcycle could cause the engine to keep running, which could result in a fire, or could result in injury from moving parts such as the rear wheel.

If the motorcycle falls down, turn the ignition switch off immediately. Ask your authorized Suzuki dealer to inspect the motorcycle for unseen damage.

INSTRUMENT PANEL

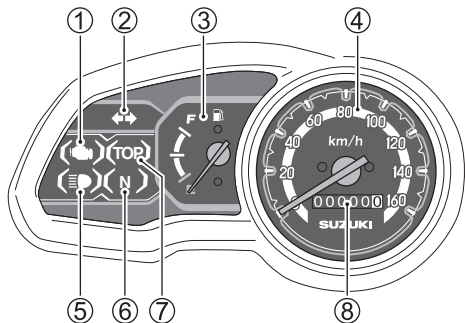

The malfunction indicator light ① comes on when the ignition switch is turned to the “ON” position. As soon as the engine is started, the malfunction indicator light ① should go out.

MALFUNCTION INDICATOR LIGHT “” ①
If the fuel injection system fails, the malfunction indicator light ① comes on in following two modes;

- A. The malfunction indicator light ① comes on and remains lit.
- B. The malfunction indicator light ① blinks slowly.

The engine may continue to run in mode A, but the engine may not run in mode B.

NOTICE

The malfunction indicator light comes on to indicate a problem with the fuel injection system.

If the malfunction indicator light comes on, have your authorized Suzuki dealer or a qualified mechanic inspect the fuel injection system as soon as possible.

NOTE: If the indicator light comes on and blinks quickly, the battery voltage is lower. Ask your authorized Suzuki dealer to inspect the motorcycle.

TURN SIGNAL INDICATOR LIGHT “” ②

When the turn signals are being operated either to the right or to the left, the indicator light will blink intermittently.

NOTE: If a turn signal light is not operating properly due to bulb filament or circuit failure, the indicator light blinks more quickly to notify the rider of the existence of a problem.

FUEL METER “” ③

The “E” mark indicates the fuel tank is empty or nearly so. The “F” mark indicates the fuel tank is full.

NOTE: The fuel meter will not indicate correctly when the motorcycle is placed on the side stand. Turn the ignition switch to the “ON” position when the motorcycle is held upright.

SPEEDOMETER ④

The speedometer indicates the road speed in kilometers per hour.

HIGH BEAM INDICATOR LIGHT “” ⑤

The blue indicator light will be lit when the headlight high beam is turned on.

NEUTRAL INDICATOR LIGHT “N” ⑥

The green light will come on when the transmission is in neutral. The light will go out when you shift into any gear other than neutral.

TOP GEAR POSITION INDICATOR LIGHT ⑦

The top gear indicator light will come on when the transmission is in top gear.

ODOMETER ⑧

The odometer registers the total distance that the motorcycle has been ridden. The odometer ranges from 0 to 99999.9.

LEFT HANDLEBAR

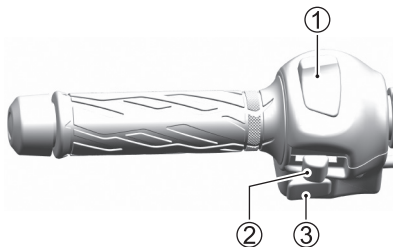

DIMMER SWITCH ①



“” position

The headlight low beam turns on.

“” position

The headlight high beam turns on. The high beam indicator light also comes on.

NOTICE

Holding the dimmer switch between the “” and “” position will light both the high and low headlight beam. This improper operation can damage the motorcycle’s headlight.

Use the dimmer switch to select only the “” or “” position.

NOTICE

Sticking tape or placing objects in front of the headlight can obstruct headlight heat radiation. This can result in headlight damage.



Do not stick tape on the headlight or place objects in front of the headlight.

NOTICE

Do not put objects in front of the headlight or taillight when they are on, and do not cover with clothes when the motorcycle is stopped.

This may cause melting of the lens or damage to the object by the heat from the lens.

TURN SIGNAL LIGHT SWITCH “” ②

Moving the switch to the “” position will flash the left turn signals. Moving the switch to the “” position will flash the right turn signals. The indicator light will also flash intermittently. To cancel turn signal operation, push the switch in.

WARNING

Failure to use the turn signals, and failure to turn off the turn signals can be hazardous. Other drivers may misjudge your course and this may result in an accident.

Always use the turn signals when you intend to change lanes or make a turn. Be sure to turn off the turn signals after completing the turn or lane change.

HORN SWITCH “” ③

Press the switch to sound the horn.

RIGHT HANDLEBAR

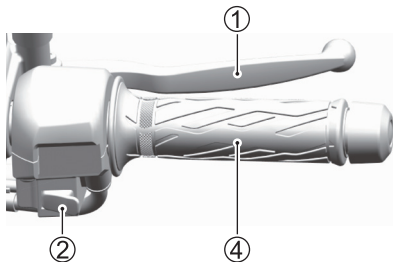

FRONT BRAKE LEVER ①

The front brake is applied by squeezing the brake lever gently toward the throttle grip. This motorcycle is equipped with a disk brake system and excessive pressure is not required to slow the machine down properly. The brake light will be lit when the lever is squeezed inward.

ELECTRIC STARTER SWITCH “” ②

Push in the electric starter switch to operate the starter motor.

NOTICE

Engaging the starter motor for more than five seconds at a time can damage the starter motor and wiring harness from overheating.

Do not engage the starter motor for more than five seconds at a time. If the engine does not start after several attempts, check the fuel supply, ignition system and air screw. Refer to the TROUBLE-SHOOTING section in this manual.

LIGHT SWITCH ③

“☀️” position

Headlight and taillight come on when the engine is running.

“●” position

All lights go off.

THROTTLE GRIP ④

Engine speed is controlled by the position of the throttle grip. Turn it towards you to increase engine speed. Turn it away from you to decrease engine speed.

FUEL TANK CAP

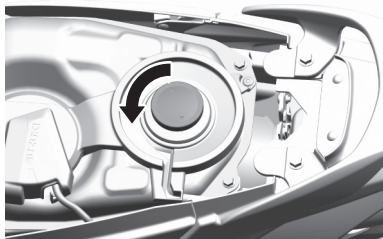

The fuel tank cap is located under the seat. To open the fuel tank cap, turn it counter-clockwise. To close the fuel tank cap, align the cap guides with the slots of the filler neck and turn it clockwise.

Use fresh gasoline when filling up the fuel tank. Do not use bad gasoline which is contaminated with dirt, dust, water or other liquid. Be careful that dirt, dust or water do not enter the fuel tank when refueling.

Fuel tank capacity: 4.0 L

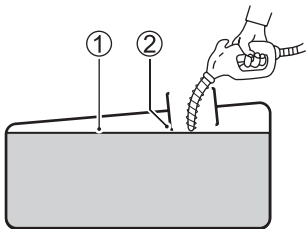

- ① Fuel level
- ② Filler neck

⚠ WARNING

If you overfill the fuel tank, fuel may overflow when it expands due to engine heat or heating by the sun. Fuel that overflows can catch fire.

Stop adding fuel when the fuel level reaches the bottom of the filler neck.

⚠ WARNING

Failure to follow safety precautions when refueling could result in a fire or cause you to breathe toxic fumes.

Refuel in a well ventilated area. Make sure the engine is off and avoid spilling fuel on a hot engine. Do not smoke, and make sure there are no open flames or sparks in the area. Avoid breathing gasoline vapors. Keep children and pets away when you refuel the motorcycle.

KICK STARTER LEVER

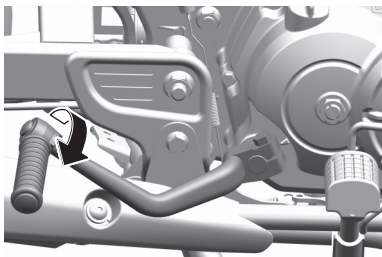
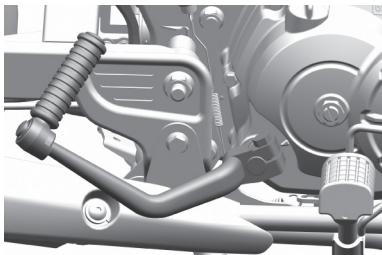

This motorcycle is equipped with a kick starter lever located on the right side of the engine. To start the engine, place the motorcycle on the center stand and depress the kick starter lever forcefully.

WARNING

An improperly retracted kick starter lever can interfere with rider control.

Be sure the kick starter lever is returned to its home position after starting the engine.

GEARSHIFT LEVER

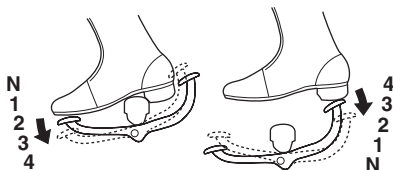
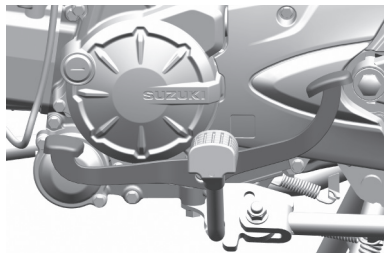

This motorcycle has a 4-speed transmission which operates as shown. To shift properly, close the throttle at the same time you operate the gearshift lever. Depress the front end of the gearshift lever to upshift and depress the rear end of the lever to downshift.

NOTE: The transmission can be shifted from 4th to neutral when the motorcycle is not moving.

REAR BRAKE PEDAL

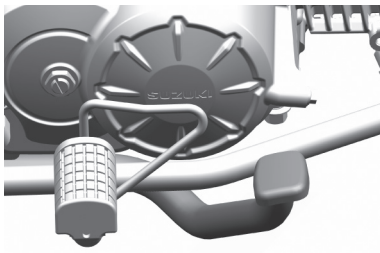

Depressing the rear brake pedal will apply the rear brake. The brake light will be lit when the rear brake is operated.

SEAT LOCK AND HELMET HOLDERS

SEAT LOCK

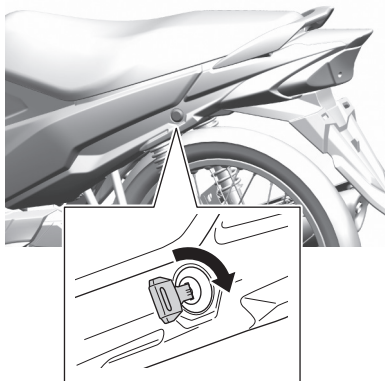

To unlock the seat lock, insert the ignition key into the lock and turn it clockwise.

To lock the seat, push down firmly until the seat latch snaps into the locked position.

HELMET HOLDERS

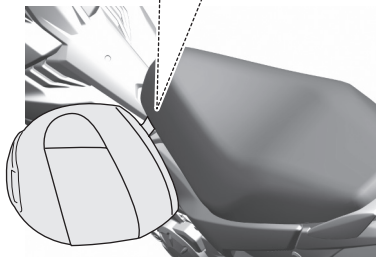
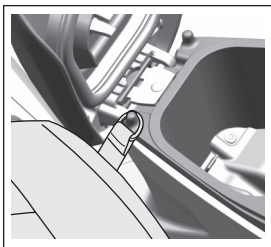

There are helmet holders under the seat. To use it, open the seat, hook your helmet fastener ring to the holder and refit the seat.

⚠ WARNING

Riding with a helmet fastened to the helmet holder can interfere with rider control.

Never carry a helmet fastened to a helmet holder. Fix the helmet securely atop the seat if you must carry it.

LUGGAGE BOX



The luggage box load capacity is 5 kg. Do not allow water to get inside the luggage box.

WARNING

Overloading the motorcycle will decrease riding stability and can lead to loss of control.

Never exceed the load capacity.

NOTE:

- *Do not keep any low heat-resistant items in the luggage box since the luggage box may get hot.*
- *Do not keep valuable items in the luggage box when leaving the motorcycle unattended.*
- *Push down the rear end of the seat if the seat does not unlock with key operation.*

STANDS

This motorcycle is equipped with a center stand and side stand.

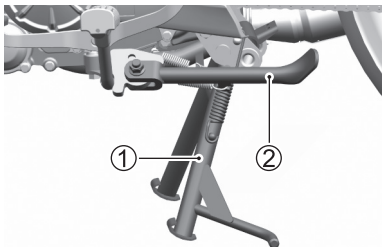

CENTER STAND ①

To place the motorcycle on the center stand, place your right foot on the stand extension, hold the handlebars with your left hand and hold the passenger hand rail with your right hand. Step on the stand extension and rock the motorcycle to the rear and upward.

SIDE STAND ②

To place the motorcycle on the side stand, place your right foot on the end of the side stand and push down firmly until the stand pivots fully through its arc and comes to rest against its stop.

⚠ WARNING

Riding with the side stand incompletely retracted can result in an accident when you turn left.

Always retract the side stand completely before starting off.

NOTICE

Park the motorcycle on firm, level ground to help prevent it from falling over.

If you must park on an incline, aim the front of the motorcycle uphill and place the motorcycle on the center stand, or the motorcycle on the side stand may roll off.





FUEL AND ENGINE OIL RECOMMENDATIONS

FUEL	3-2
OXYGENATED FUEL RECOMMENDATION	3-2
ENGINE OIL	3-4

FUEL AND ENGINE OIL RECOMMENDATIONS

FUEL

Use unleaded gasoline with an octane rating of 91 or higher (Research method).

Unleaded gasoline can extend spark plug life and exhaust components life.

NOTE:

- *If the engine develops some trouble like lack of acceleration or insufficient power, the cause may be due to the fuel the motorcycle uses. In such case, try changing to a different gas station. If the situation is not improved by changing, consult your Suzuki dealer.*
- *If pinking or knocking is experienced, substitute higher octane grade gasoline or another brand, because there are differences between brands.*

OXYGENATED FUEL RECOMMENDATION

Oxygenated fuels which meet the minimum octane requirement and the requirements described below may be used in your motorcycle without jeopardizing the New Vehicle Limited Warranty.

NOTE: Oxygenated fuels are fuels which contain oxygen carrying additives such as alcohol.

Gasoline/Ethanol Blends

Blends of unleaded gasoline and ethanol (grain alcohol), also known as "GASOHOL", are commercially available in some areas. Blends of this type may be used in your motorcycle if they are no more than 10% ethanol. Make sure this gasoline-ethanol blend has octane ratings no lower than those recommended for gasoline.

Use the recommended gasoline.

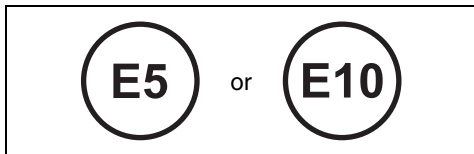

NOTE:

- *To help minimize air pollution, Suzuki recommends that you use oxygenated fuels.*
- *Be sure that any oxygenated fuel you use has recommended octane ratings.*
- *If you are not satisfied with the drivability of your motorcycle when you are using an oxygenated fuel, or if engine pinging is experienced, substitute another brand as there are differences between brands.*

NOTICE

Spilled gasoline containing alcohol can damage the painted surfaces of your motorcycle.

Be careful not to spill any fuel when filling the fuel tank. Wipe spilled gasoline up immediately.

NOTICE

Do not use leaded gasoline.

Use of leaded gasoline causes the catalytic converter to malfunction.

ENGINE OIL

Use Suzuki genuine engine oil or equivalent. If Suzuki genuine engine oil is not available, select a proper engine oil according to the following guideline.

Oil quality is a major contributor to your engine's performance and life. Always select good quality engine oil. Use oil with an API (American Petroleum Institute) classification of SG, SH, SJ, SL, SM or SN with a JASO classification of MA (MA1, MA2).

SAE	API	JASO
10W-40	SG, SH, SJ, SL, SM or SN	MA (MA1, MA2)

API: American Petroleum Institute

JASO: Japanese Automobile Standards Organization

SAE Engine Oil Viscosity

Suzuki recommends the use of SAE 10W-40 engine oil. If SAE 10W-40 engine oil is not available, select an alternative according to the following chart.

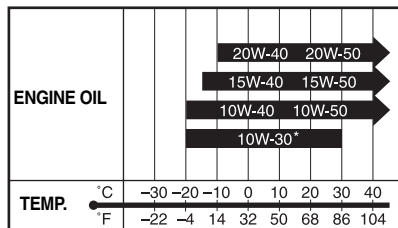

* USE ONLY SG, SH, SJ or SL.

JASO T903

The JASO T903 standard is an index to select engine oils for 4-stroke motorcycle and ATV engines. Motorcycle and ATV engines lubricate clutch and transmission gears with engine oil. JASO T903 specifies performance requirements for motorcycle and ATV clutches and transmissions.

There are two classes, MA (MA1, MA2) and MB. For example, the oil container shows the classification as follows.

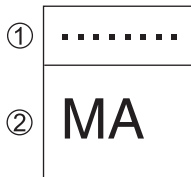

- ① Code number of oil sales company
- ② Oil classification

Energy Conserving

Suzuki does not recommend the use of “ENERGY CONSERVING” or “RESOURCE CONSERVING” oils. Some engine oils which have an API classification of SH, SJ, SL, SM or SN have an “ENERGY CONSERVING” or “RESOURCE CONSERVING” indication in the API classification donut mark. These oils can affect engine life and clutch performance.

API SG, SH, SJ, SL, SM or SN



Recommended

API SH, SJ, SL or SM

API SN



Not recommended

BREAK-IN (RUNNING-IN) AND INSPECTION BEFORE RIDING

MAXIMUM THROTTLE OPERATION RECOMMENDATION	4-2
VARY THE ENGINE SPEED	4-2
BREAKING IN THE NEW TIRES	4-3
AVOID CONSTANT LOW SPEED	4-3
OBSERVE YOUR FIRST AND MOST CRITICAL SERVICE	4-4
INSPECTION BEFORE RIDING	4-4

BREAK-IN (RUNNING-IN) AND INSPECTION BEFORE RIDING

The foreword explains how important proper break-in is to achieve maximum life and performance from your new Suzuki. The following guidelines explain proper break-in procedures.

MAXIMUM THROTTLE OPERATION RECOMMENDATION

This table shows the maximum recommended throttle operation during the break-in period.

Initial	800 km	Less than 1/2 throttle
Up to	1600 km	Less than 3/4 throttle

VARY THE ENGINE SPEED

The engine speed should be varied and not held at a constant speed. This allows the parts to be “loaded” with pressure, and then unloaded, allowing the parts to cool. This aids the mating process of the parts. It is essential that some stress be placed on the engine components during break-in to ensure this mating process. Do not, though, apply excessive load on the engine.

BREAKING IN THE NEW TIRES

New tires need proper break-in to assure maximum performance, just as the engine does. Wear in the tread surface by gradually increasing your cornering lean angles over the first 160 km before attempting maximum performance. Avoid hard acceleration, hard cornering, and hard braking for the first 160 km.

WARNING

Failure to perform break-in of the tires could cause tire slip and loss of control.

Use extra care when riding on new tires. Perform proper break-in of the tires as described in this section and avoid hard acceleration, hard cornering, and hard braking for the first 160 km.

AVOID CONSTANT LOW SPEED

Operating the engine at constant low speed (light load) can cause parts to glaze and not seat in. Allow the engine to accelerate freely through the gears, without exceeding the recommended maximum limits. Do not, however, use full throttle for the first 1600 km.

OBSERVE YOUR FIRST AND MOST CRITICAL SERVICE

The initial service (1000 km maintenance) is the most important service your motorcycle will receive. During break-in operation, all of the engine components will have mated together and seated. Maintenance required as part of the initial service includes correction of all adjustments, tightening of all fasteners and replacement of dirty oil. Timely performance of this service will help make sure you get the best service life and performance from the engine.

NOTE: The 1000 km service should be performed as outlined in the INSPECTION AND MAINTENANCE section of this Owner's Manual. Pay particular attention to the CAUTION and WARNING messages in that section.

INSPECTION BEFORE RIDING

WARNING

Failure to inspect your motorcycle before riding and to properly maintain your motorcycle increases the chances of an accident or equipment damage.

Always inspect your motorcycle each time you use it to make sure it is in safe operating condition. Refer to the INSPECTION AND MAINTENANCE section in this owner's manual.

WARNING

If you operate this motorcycle with improper tires or improper or uneven tire pressure, you may lose control of the motorcycle. This will increase your risk of an accident.

Always use tires of the size and type specified in this owner's manual. Always maintain proper tire pressure as described in the **INSPECTION AND MAINTENANCE** section.

Before riding the motorcycle, be sure to check the following items. Never underestimate the importance of these checks. Perform all of them before riding the machine.

WARNING

Checking maintenance items when the engine is running can be hazardous. You could be severely injured if your hands or clothing get caught in moving engine parts.

Shut the engine off when performing maintenance checks, except when checking the lights and throttle.

WHAT TO CHECK	CHECK FOR:
Steering	<ul style="list-style-type: none"> • Smoothness • No restriction of movement • No play or looseness
Brakes (☞ 2-12, 2-17,6-37)	<ul style="list-style-type: none"> • Proper pedal and lever operation • Fluid level in the reservoir to be above "LOWER" line • Correct pedal and lever play • No "sponginess" • No fluid leakage • Brake pads/shoes not to be worn down to the limit line • No dragging
Drive chain (☞ 6-31)	<ul style="list-style-type: none"> • Correct tension or slack • Adequate lubrication • No excessive wear or damage
Tires (☞ 6-46)	<ul style="list-style-type: none"> • Proper pressure • Adequate tread depth • No cracks or cuts
Fuel (☞ 2-9)	Enough fuel for the planned distance of operation
Lighting (☞ 2-5, 2-8, 2-10)	Operation of all lights and indicators

Horn (☞ 2-11)	Correct function
Engine oil (☞ 6-25)	Correct level
Throttle (☞ 6-20)	<ul style="list-style-type: none"> • Correct play in the throttle cable • Smooth operation and positive return of the throttle grip to the closed position

RIDING TIPS

STARTING THE ENGINE	5-2
STARTING OFF	5-3
USING THE TRANSMISSION	5-5
RIDING ON HILLS	5-6
STOPPING AND PARKING	5-6

RIDING TIPS

STARTING THE ENGINE

Shift the transmission to neutral. Place the motorcycle on the center or side stand. Insert the ignition key into the ignition switch and turn it to the “ON” position.

WARNING

Starting the engine improperly can be hazardous. Starting the engine with the center stand released can move motorcycle forward as soon as engine starts.

Place the motorcycle on the center stand before starting the engine and do not release the center stand until engine revs at idling speed.

When the Engine is Cold or Warm:

1. Squeeze the front brake lever.
2. Close the throttle grip and push the electric starter switch or depress the kick starter lever.

When a Cold or Warm Engine is Hard to Start:

1. Squeeze the front brake lever.
2. Open the throttle grip 1/8, push the electric starter switch or depress the kick starter lever.

WARNING

Exhaust gas contains carbon monoxide, a dangerous gas that is difficult to detect because it is colorless and odorless. Breathing carbon monoxide can cause death or severe injury.

Never start the engine or let it run indoors or where there is little or no ventilation.

NOTICE

Leaving the engine running for an extended period or keeping the throttle opened, without traveling, in order to charge the battery, etc., may cause the engine to overheat. Overheating may damage engine parts or motorcycle parts, and cause the exhaust pipe to change color.

Stop the engine if you do not intend to begin riding promptly.

STARTING OFF

WARNING

Riding at excessive speeds increases your chances of losing control of the motorcycle, which can result in an accident.

Always ride at a speed that is proper for the terrain, visibility and operating conditions, and your skills and experience.

WARNING

If you remove even one hand or foot from the motorcycle, you can reduce your ability to control the motorcycle. This could cause you to lose your balance and fall off the motorcycle. If you remove a foot from a footrest, your foot or leg may come in contact with the rear wheel. This could injure you or cause an accident.

Always keep both hands on the handlebars and both feet on the footrests of your motorcycle during operation.

Open the throttle grip toward you and the motorcycle will start moving forward. Engage first gear by depressing front end of the gear shift lever downward. Twist the throttle grip toward you. The motorcycle will start moving forward. To shift to the next higher gear, accelerate gently, then close the throttle and depress the front end of the gear shift lever to select the next gear. Select higher gears in this manner until top gear is reached.

WARNING

Sudden side winds, which can occur when being passed by larger vehicles, at tunnel exits or in hilly areas, can cause you to lose control of the motorcycle.

Reduce your speed and be alert to the possibility of sudden side winds.

USING THE TRANSMISSION

The transmission is provided to keep the engine operating smoothly in its normal operating speed range. The gear ratios have been carefully chosen to meet the characteristics of the engine. The rider should always select the most suitable gear for the prevailing conditions.

WARNING

Downshifting when engine speed is too high can;

- **cause the rear wheel to skid and lose traction due to increased engine braking, resulting in an accident; or**
- **force the engine to overrev in the lower gear, resulting in engine damage.**

Reduce speed before downshifting.

WARNING

Downshifting while the motorcycle is leaned over in a corner may cause rear wheel skid and loss of control.

Reduce your speed and downshift before entering the corner.

NOTICE

Improper gearshift lever operation can damage the transmission.

- **Do not rest your foot on the gearshift lever.**
- **Do not use force to shift gears.**

RIDING ON HILLS

- When climbing steep hills, the motorcycle may begin to slow down and show lack of power. At this point you should shift to a lower gear so that the engine will again be operating in its normal power range. Shift rapidly to prevent the motorcycle from losing momentum.
- When riding down a steep hill, the engine may be used for braking by shifting to a lower gear.
- Be careful, however, not to allow the engine to overrev.

STOPPING AND PARKING

1. Twist the throttle grip away from yourself to close the throttle completely.
2. Apply the front and rear brakes evenly and at the same time.

WARNING

Inexperienced riders tend to underutilize the front brake. This can cause excessive stopping distance and lead to a collision. Using only the front or rear brake can cause skidding and loss of control.

Apply both brakes evenly and at the same time.

⚠ WARNING

Hard braking while turning may cause wheel skid and loss of control.

Brake before you begin to turn.

⚠ WARNING

Hard braking on wet, loose, rough, or other slippery surfaces can cause wheel skid and loss of control.

Brake lightly and with care on slippery or irregular surfaces.

⚠ WARNING

Following another vehicle too closely can lead to a collision. As vehicle speeds increase, stopping distance increases progressively.

Always maintain a safe stopping distance between you and the vehicle in front of you.

NOTICE

Holding the motorcycle stopped with throttle operation on inclines can damage the motorcycle's clutch.

Use the brakes when stopping the motorcycle on inclines.

3. Park the motorcycle on a firm, flat surface where it will not fall over.
4. Apply the side stand or center stand.

NOTE: If the motorcycle is to be parked on the side stand on a slight slope, the front end of the motorcycle should face “up” the incline to avoid rolling forward off the side stand.

5. Turn the ignition switch to the “OFF” position to stop the engine.
6. Turn the ignition switch to the “LOCK” position to lock the steering.
7. Remove the ignition key from the switch.

NOTE: If an optional anti-theft lock such as a U-shape lock, brake disk lock or chain is used to avoid theft, be sure to remove the anti-theft lock before moving the motorcycle.

CAUTION

A hot muffler can cause severe burns. The muffler will be hot enough to cause burns for some time after stopping the engine.

Park the motorcycle where pedestrians or children are not likely to touch the muffler.

INSPECTION AND MAINTENANCE

MAINTENANCE SCHEDULE	6-2
TOOLS	6-5
LUBRICATION POINTS	6-5
BATTERY	6-7
SPARK PLUG	6-11
AIR CLEANER	6-14
IDLE SPEED ADJUSTMENT	6-19
THROTTLE CABLE PLAY	6-20
FUEL HOSE	6-21
ENGINE OIL	6-25
DRIVE CHAIN	6-31
BRAKES	6-37
FRONT BRAKE	6-38
REAR BRAKE	6-42
SPOKE NIPPLE TIGHTNESS	6-45
TIRES	6-46
LIGHT BULB REPLACEMENT	6-50
FUSE	6-57
CATALYTIC CONVERTER	6-58

INSPECTION AND MAINTENANCE

MAINTENANCE SCHEDULE

The chart indicates the intervals between periodic services in kilometers and months. At the end of each interval, be sure to inspect, check, lubricate and service as instructed. If your motorcycle is used under high stress conditions such as continuous full throttle operation, or is operated in a dusty climate, certain services should be performed more often to ensure reliability of the motorcycle as explained in the maintenance section. Your Suzuki dealer can provide you with further guidelines. Steering components, suspension and wheel components are key items and require very special and careful servicing. For maximum safety we suggest that you have these items inspected and serviced by your authorized Suzuki dealer or a qualified service mechanic.

WARNING

Improper maintenance or failure to perform recommended maintenance can lead to an accident.

Keep your motorcycle in good condition. Ask your Suzuki dealer or a qualified mechanic to perform the maintenance items marked with an asterisk (*). You may perform the unmarked maintenance items by referring to the instructions in this section, if you have mechanical experience. If you are not sure how to do any of the jobs, ask your Suzuki dealer to do the maintenance.

WARNING

Exhaust gas contains carbon monoxide, a dangerous gas that is difficult to detect because it is colorless and odorless. Breathing carbon monoxide can cause death or severe injury.

Never start the engine or let it run indoors or where there is little or no ventilation.

NOTICE

Poorly-made replacement parts can cause your motorcycle to wear more quickly and may shorten its useful life.

When replacing parts on your motorcycle, use only genuine Suzuki replacement parts or their equivalent.

NOTICE













Servicing electric parts with the ignition switch in the “ON” position can damage the electric parts when the electric circuit is shorted.

Turn off the ignition switch before servicing the electric parts to avoid short-circuit damage.

NOTE: The MAINTENANCE CHART specifies the minimum requirements for maintenance. If you use your motorcycle under severe conditions, perform maintenance more often than shown in the chart. If you have any questions regarding maintenance intervals, consult your Suzuki dealer or a qualified mechanic.

MAINTENANCE CHART

Interval: This interval should be judged by number of months or odometer reading, whichever comes first.

Item	Interval	1000	4000	8000	12000	16000	20000
	km Months	1	4	8	12	16	24
Air cleaner element ( 6-14)		-	I	I	R	I	I
*Replace every 12000 km							
*Cylinder head nuts, cylinder nuts, exhaust pipe and muffler bolts and nut		T	T	T	T	T	T
*Valve clearance		I	I	I	I	I	I
Sparkplug ( 6-11)		-	I	I	R	I	I
*Replace every 10000 km							
Fuel Hose ( 6-21)		-	I	I	I	I	I
*Replace every 4 years							
Engine oil ( 6-25)		R	R	R	R	R	R
Engine oil filter ( 6-25)		R	R	R	R	R	R
Throttle cable play ( 6-20)		I	I	I	I	I	I
Idle speed ( 6-19)		I	I	I	I	I	I
Drive chain ( 6-31)		I	I	I	I	I	I
Clean and lubricate every 1000km							
*Brakes ( 6-37)		I	I	I	I	I	I
Brake hose ( 6-37)		I	I	I	I	I	R
*Replace every 4 years							
Brake fluid ( 6-38)		I	I	I	I	I	R
*Replace every 2 years							
Tires ( 6-46)		I	I	I	I	I	I
*Steering		I	-	I	I	I	I
*Front fork		-	I	-	I	-	I
*Rear suspension		-	-	I	-	-	I
*Chassis nuts and bolts		T	T	T	T	T	T
Lubrication ( 6-5)		Lubricate every 1000km					

NOTE: I= Inspect and clean, adjust, replace or lubricate as necessary; R= Replace; T= Tighten

TOOLS

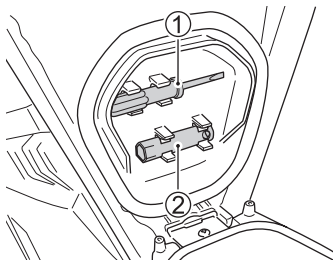

A tool kit is provided with your motorcycle. It is located on the underside of the seat.

- ① Screwdriver (+, -)
- ② Socket wrench (16 mm)

LUBRICATION POINTS

Proper lubrication is important for smooth and long life of each working part of your motorcycle and also for safe riding. It is a good practice to lubricate the motorcycle after a long rough ride and after getting it wet in the rain or after washing it. Major lubrication points are indicated below.

NOTICE

Lubricating electrical switches can damage the switches.

Do not apply grease or oil to electrical switches.



G..... Grease

D..... Drive chain lubricant

①..... Side stand pivot and spring hook

②..... Center stand pivot and spring hook

③..... Drive chain

④..... Front brake lever pivot

⑤..... Kick starter lever pivot

⑥..... Brake pedal pivot

BATTERY

The battery is a sealed type battery and requires no maintenance. Have your dealer check the battery's state of charge periodically.

NOTE:

- *For charging a sealed type battery, use a battery charger applicable to a sealed type battery.*
- *If you cannot charge the battery, consult your authorized Suzuki dealer.*

WARNING

Battery posts, terminals, and related accessories contain lead and lead compounds. Lead is harmful to your health if it gets into your blood stream.

Wash hands after handling any parts containing lead.

WARNING

Diluted sulfuric acid from the battery can cause blindness or severe burns.

When working near the battery, use proper eye protection and gloves. Flush eyes or body with ample water and get medical care immediately if you suffer injury. Keep batteries out of reach of children.

WARNING

Batteries produce flammable hydrogen gas which can explode if exposed to flames or sparks.

Keep flames and sparks away from the battery. Never smoke when working near the battery.

⚠ WARNING

Wiping the battery with a dry cloth can cause a static electricity spark, which can start a fire.

Wipe the battery with a damp cloth to avoid static electricity build up.

NOTICE

Exceeding the maximum charging rate for the battery can shorten its life.

Never exceed the maximum charging rate for the battery.

BATTERY REMOVAL

To remove the battery, follow the procedure below:

1. Place the motorcycle on the center stand.
2. Open the seat by referring to the SEAT LOCK AND HELMET HOLDERS section.

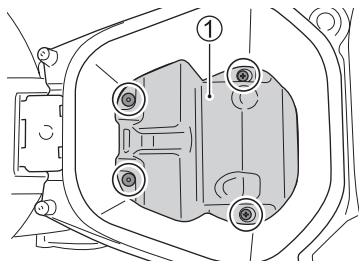

3. Remove the screws and fasteners completely from the motorcycle.
4. Remove the battery box lid ①.

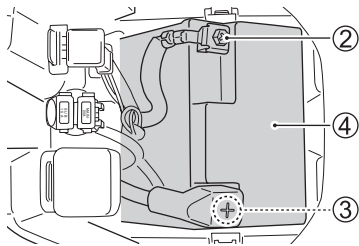

5. Disconnect the negative (-) terminal ②.
6. Remove the cap. Disconnect the positive (+) terminal ③.
7. Remove the battery ④.

To install the battery:

1. Install the battery in the reverse order of removal.
2. Connect the battery terminals securely. Reinstall the cap.

NOTICE

Reversing the battery lead wires can damage the charging system and the battery.

Always attach the red lead to the (+) positive terminal and the black (or black with white tracer) lead to the (-) negative terminal.

WARNING

Batteries contain toxic substances including sulfuric acid and lead. They could cause injury to humans or could damage the environment.

A used battery must be disposed of or recycled according to local law and must not be discarded with ordinary household waste. Make sure not to tip over the battery when you remove it from the motorcycle. Otherwise, sulfuric acid could run out and you might be injured.

NOTE:

- *Select the same type MF battery when replacing the battery.*
- *Recharge the battery once a month if the motorcycle is not used for a long time.*



The crossed-out wheeled bin symbol **(A)** located on the battery label indicates that a used battery should be collected separately from ordinary household waste.

The chemical symbol of "Pb" **(B)** indicates the battery contains more than 0.004% lead.

By ensuring the used battery is disposed of or recycled correctly, you will help prevent potential negative consequences for the environment and human health, which could otherwise be caused by inappropriate waste handling of the battery. The recycling of materials will help to conserve natural resources. For more detailed information about disposing or recycling of the used battery, consult your Suzuki dealer.

SPARK PLUG

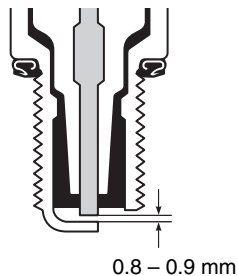

Adjust the spark plug gap to 0.8 – 0.9 mm by using a spark plug gap thickness gauge. The spark plug should be replaced periodically.

NOTICE

An improper spark plug may have an incorrect fit or inappropriate heat range for your engine. This may cause severe engine damage which may not be covered under warranty.

Use one of the spark plugs listed or their equivalent. Consult your Suzuki dealer if you are not sure which spark plug is correct for your type of usage.

PLUG REPLACEMENT GUIDE

NGK	DENSO	REMARKS
CPR6EA-9	U20EPR9	If the standard plug is apt to get wet, replace with this plug.
CPR7EA-9	U22EPR9	Standard
CPR8EA-9	U24EPR9	If the standard plug is apt to overheat, replace with this plug.

To remove the spark plug, follow the procedure below:

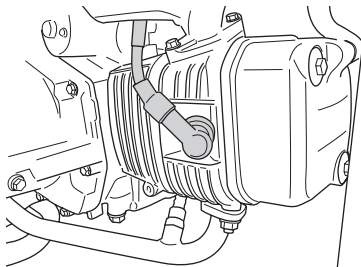

1. Disconnect the spark plug cap.
2. Remove the spark plug with a spark plug wrench.

INSTALLATION

NOTICE

Improper installation of the spark plug can damage your motorcycle. An overly-tight or cross-threaded spark plug will damage the aluminum threads of the cylinder head.

Carefully turn the spark plug by hand into the threads. If the spark plug is new, tighten it with a wrench about 1/2 turn past finger tight. If you are reusing the old spark plug, tighten it with a wrench about 1/8 turn past finger tight.

NOTICE

Dirt can damage the moving engine parts of your motorcycle if it enters an open spark plug hole.

Cover the spark plug hole while the spark plug is out of the hole.

AIR CLEANER

If the element has become clogged with dust, intake resistance will increase with a resultant decrease in power output and an increase in fuel consumption. If you use your motorcycle under normal low-stress conditions, you should service the air cleaner at the intervals specified. If you ride in dusty, wet or muddy conditions, you will need to inspect the air cleaner element much more frequently. Use the following procedure to remove the element and inspect it.

WARNING

Operating the engine without the air cleaner element in place can be hazardous. A flame can spit back from the engine to the air intake box without the air cleaner element to stop it. Severe engine damage can also occur if dirt enters the engine due to running the engine without the air cleaner element.

Never run the engine without the air cleaner element in place.

NOTICE

Failure to inspect the air cleaner element frequently if the vehicle is used in dusty, wet, or muddy conditions can damage your motorcycle. The air cleaner element can become clogged under these conditions, and engine damage may result.

Always inspect the air cleaner element after riding in severe conditions. Replace the element as necessary. If water gets in the air cleaner case, immediately clean the element and the inside of the case.

Follow the procedure below to remove the air cleaner element.

1. Place the motorcycle on the center stand.

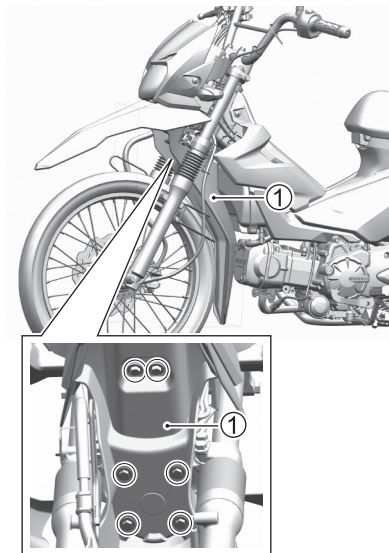

2. Remove the bolts and remove the front fender (lower) ①.

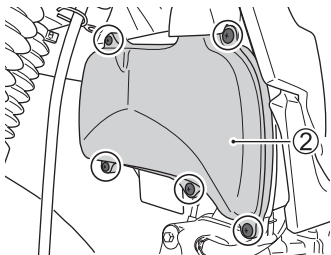

3. Remove the screws and remove the air cleaner cap ②.

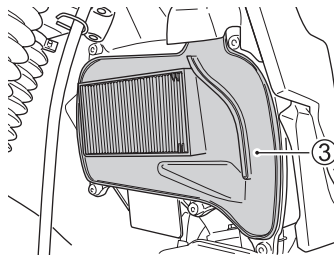

4. Remove the air cleaner element ③.

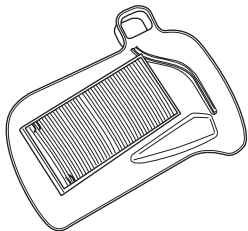

5. Inspect the air cleaner element condition. Replace the air cleaner element periodically.

NOTICE

Compressed air can damage the air cleaner element.

Do not blow the air cleaner element with compressed air.

6. Reinstall the checked element or new air cleaner element in reverse order of removal. Be absolutely sure that the element is securely in position and is sealing properly.

NOTICE

A torn air cleaner element will allow dirt to enter the engine and can damage the engine.

Replace the air cleaner element with a new one if it is torn. Carefully examine the air cleaner element for tears during cleaning.

NOTICE

Failure to position the air cleaner element properly can allow dirt to bypass the air cleaner element. This will cause engine damage.

Be sure to properly install the air cleaner element.

NOTE: Be careful not to spray water on the air cleaner box when cleaning the motorcycle.

AIR CLEANER DRAIN PLUG

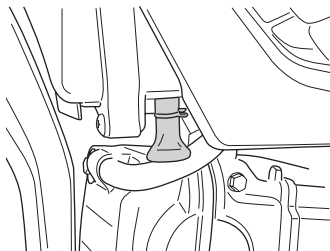

Remove the plug and drain water and oil at the periodic maintenance interval. The air cleaner drain plug is located beneath the air cleaner box.

IDLE SPEED ADJUSTMENT

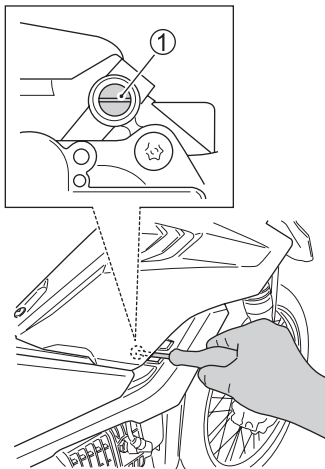

1. Start up the engine and let the engine run until it warms up fully.
2. After engine warms up, turn the air screw ① in or out so that engine may run at 1300 – 1500 r/min.

NOTE: If you have a tachometer, you can do this adjustment by referring to the procedures described above. If you do not have one, ask your Suzuki dealer or a qualified mechanic to perform this adjustment.

THROTTLE CABLE PLAY

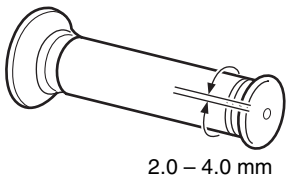
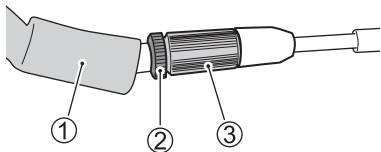

To adjust the cable play:

1. Remove the boot ①.
2. Loosen the lock nut ②.
3. Turn the adjuster ③ so that the throttle grip has 2.0 – 4.0 mm play.
4. Tighten the lock nut ②.
5. Replace the boot ①.

⚠ WARNING

Inadequate throttle cable play can cause engine speed to rise suddenly when you turn the handlebars. This can lead to loss of control and an accident.

Adjust the throttle cable play so that engine idle speed does not rise due to handlebar movement.

THROTTLE CABLE BOOTS

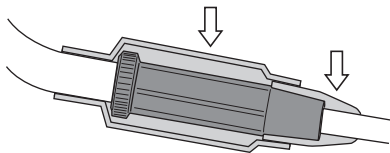

The throttle cable has boots. Check that the boots are fit securely. Do not apply water directly to the boots when washing. Wipe off dirt from the boots with a wet cloth when the boots are dirty.

FUEL HOSE

LEG SHIELD REMOVAL AND FRONT FRAME COVER REMOVAL

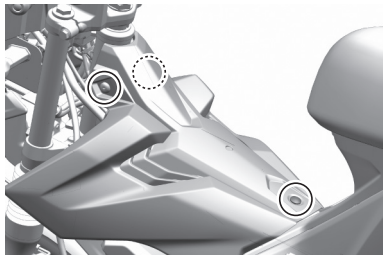

1. Remove the three screws.

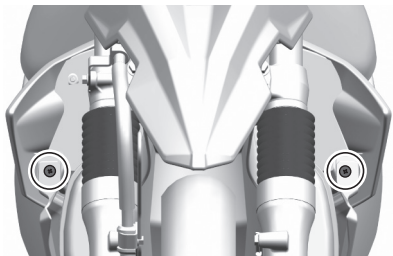

2. Remove the right and left screws.

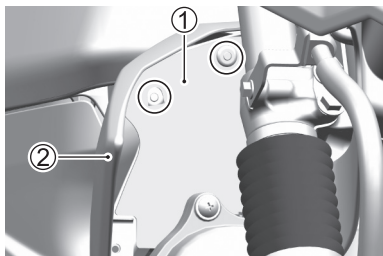

3. Remove the fasteners and remove the mud guard ① from the leg shield ②.

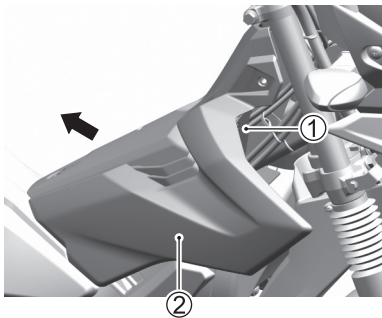

4. Remove the mud guard ① and leg shield ②.

After removing the leg shield ②;

5. Open the seat by referring to the SEAT LOCK AND HELMET HOLDERS section.

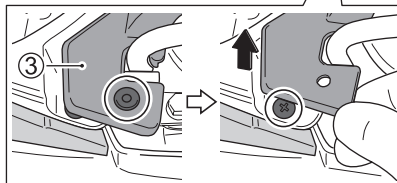
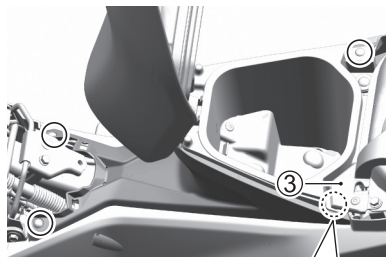

6. Remove the screws. There are screws under the fuel tank cover ③. Remove the fastener, and then remove the screw while pulling up the cover as shown.

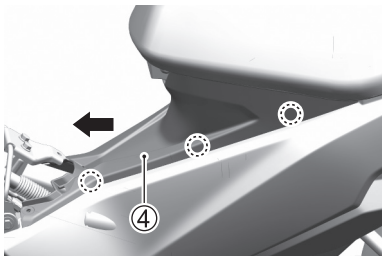

7. Unhook the hooks and remove the front frame cover ④.

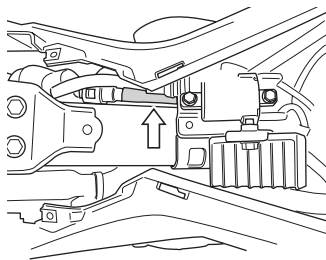
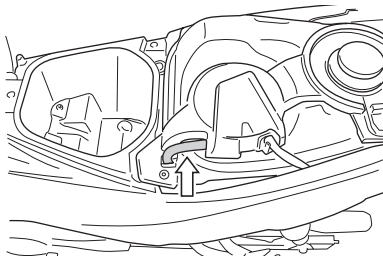

8. Inspect the fuel hose for damage and fuel leakage. If any defects are found, the fuel hose must be replaced.

ENGINE OIL

Long engine life depends much on the selection of a quality oil and the periodic changing of the oil. Daily oil level checks and periodic changes are two of the most important maintenance items to be performed.

ENGINE OIL LEVEL CHECK

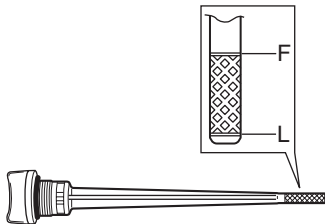

Check the engine oil level with the engine oil dipstick. The dipstick comes out together with the oil filler cap as shown. The level found in the dipstick should be between “L” (Low) and “F” (Full) lines.

The oil level inspection should be performed under the following conditions:

1. Place the motorcycle on the center stand.
2. Start the engine and run it for three minutes.
3. Stop the engine and wait three minutes.
4. Hold the motorcycle vertically and inspect the engine oil level with the engine oil dipstick.

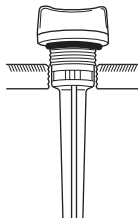

NOTE: Do not screw in the oil filler cap when checking the engine oil level.

NOTICE

Operating the motorcycle with too little or too much oil can damage the engine.

Place the motorcycle on level ground. Check the oil level with the engine oil dipstick before each use of the motorcycle. Be sure the engine oil level is always above the “L” (low) line and not higher than the “F” (full) line.

ENGINE OIL AND FILTER CHANGE

Change the engine oil and oil filter at the scheduled time. The oil should be changed when the engine is warm so that the oil will drain thoroughly from the engine. The procedure is as follows:

1. Place the motorcycle on the center or side stand.

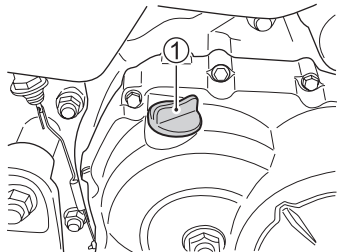

2. Remove the oil filler cap ①.
3. Place a drain pan under the drain plug.

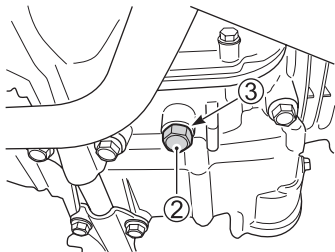

4. Remove the drain plug ② and gasket ③ with a wrench and drain out the engine oil while holding the motorcycle vertically.

⚠ CAUTION

Hot engine oil and exhaust pipes can burn you.

Wait until the oil drain plug and exhaust pipes are cool enough to touch with bare hands before draining oil.

⚠ WARNING

Children and pets may be harmed by swallowing new or used oil. Repeated, prolonged contact with used engine oil may cause skin cancer. Brief contact with oil may irritate skin.

Keep new and used oil and used oil filters away from children and pets. To minimize your exposure to used oil, wear a long-sleeve shirt and moisture-proof gloves (such as dishwashing gloves) when changing oil. If oil contacts your skin, wash thoroughly with soap and water. Launder any clothing or rags if wet with oil. Recycle or properly dispose of used oil and filters.

NOTICE

Turning the engine while draining the engine oil will cause oil film shortage and adversely affect the engine.

Do not use the electric starter switch during engine oil replacement work.

NOTE:

- *Recycle or properly dispose of used oil.*
- *Before starting the work, check that there is not any dust, mud, or foreign object inside the oil jug or on the oil filter mounting surface.*

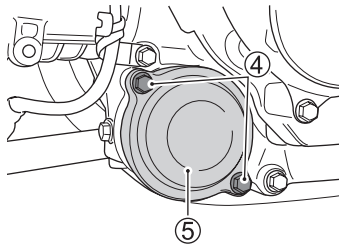

5. Remove the bolts ④ holding the filter cap ⑤ in place.

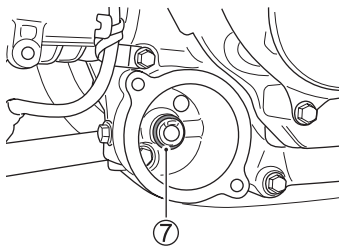
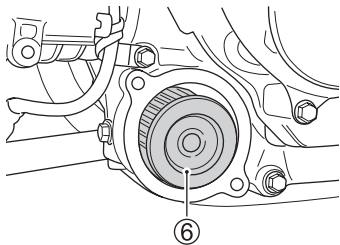

6. Replace the oil filter ⑥ and the “O” ring ⑦ with a new one.

NOTICE

Failure to use an oil filter with the correct design can damage your motorcycle's engine.

Be sure to use a genuine Suzuki oil filter or an equivalent one designed for your motorcycle.

NOTICE

Failure to insert the new oil filter correctly can damage the engine. No oil flow will result if the oil filter is inserted backwards.

Insert the open end of the new oil filter into the engine.

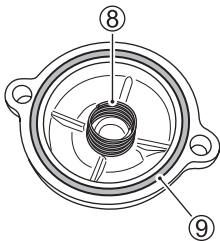

7. Before replacing the oil filter cap, be sure to check that the filter spring ⑧ and the “O” ring ⑨ are installed correctly.

NOTE: Insert a new “O” ring each time the filter element is replaced.

8. Replace the oil filter cap and tighten the bolts securely but do not overtighten them.
9. Replace the drain plug gasket ③ with a new one. Reinstall the drain plug ② and gasket ③. Tighten the plug securely with a torque wrench. Pour fresh oil through the filler hole. Approximately 800 ml will be required.

Drain plug tightening torque:
18 N·m (1.8 kgf-m, 13.0 lbf-ft)

NOTE: About 650 ml of oil will be required when changing oil only.

NOTICE

Engine damage may occur if you use oil that does not meet Suzuki’s specifications.

Be sure to use the oil specified in the FUEL AND ENGINE OIL RECOMMENDATIONS section.

10. Tighten the oil filler cap.
11. Start the engine and allow it to idle for three minutes.
12. Check the oil level according to Oil Level Check procedure.

NOTE: Check to see that no oil is leaking from the oil filter cap.

DRIVE CHAIN

The condition and adjustment of the drive chain should be checked each day before you ride. Always follow the guidelines below for inspecting and servicing the chain.

WARNING

Riding with the chain in poor condition or improperly adjusted can lead to an accident.

Inspect, adjust, and maintain the chain properly before each ride, according to the instructions in this section.

INSPECTING THE DRIVE CHAIN

When inspecting the chain, look for the following:

- Loose pins
- Damaged rollers
- Dry or rusted links
- Kinked or binding links
- Excessive wear
- Improper chain adjustment

If you find anything wrong with the drive chain condition or adjustment, correct the problem if you know how. If necessary, consult your authorized Suzuki dealer or a qualified mechanic.

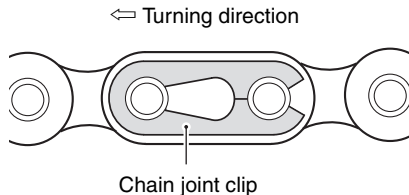
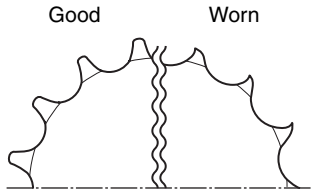

Damage to the drive chain means that the sprockets may also be damaged. Inspect the sprockets for the following:

- Excessively worn teeth
- Broken or damaged teeth
- Loose sprocket mounting nuts

If you find any of these problems with your sprocket, consult your Suzuki dealer or a qualified mechanic.

NOTE: The two sprockets should be inspected for wear when a new chain is installed and replace them if necessary.

NOTICE

Improperly attached chain joint clip may drop from the chain and cause the chain to come off the sprockets or to be caught in the engine. This may cause severe engine damage.

Attach the chain joint clip so that the slit end faces opposite to the direction of rotation.

DRIVE CHAIN CLEANING AND OILING

1. Remove dirt and dust from the drive chain.
2. Clean the drive chain with a drive chain cleaner, or water and mild detergent.

NOTICE

Cleaning the drive chain improperly can ruin the drive chain.

- **Do not use a volatile solvent such as paint thinner, kerosene and gasoline.**
- **Do not use a high pressure cleaner to clean the drive chain.**
- **Do not use a wire brush to clean the drive chain.**

3. Use a soft brush to clean the drive chain.
4. Wipe off water and neutral detergent.
5. Lubricate with a motorcycle drive chain lubricant or high viscosity oil (#80 – 90).
6. Lubricate both front and back plates of the drive chain.
7. Wipe off excess lubricant after lubricating all around the drive chain.

DRIVE CHAIN ADJUSTMENT

Check the drive chain slack at the middle between the two sprockets. The chain may require more frequent adjustment than indicated in the periodic maintenance schedule depending on your riding conditions.

WARNING

Too much chain slack can cause the chain to come off the sprockets, resulting in an accident or serious damage to the motorcycle.

Inspect and adjust the drive chain slack before each use.

To adjust the drive chain, follow these directions:

▲ CAUTION

A hot muffler can burn you. The muffler will be hot enough to burn you for some time after stopping the engine.

Wait until the muffler cools before adjusting the drive chain.

1. Place the motorcycle on the center stand.

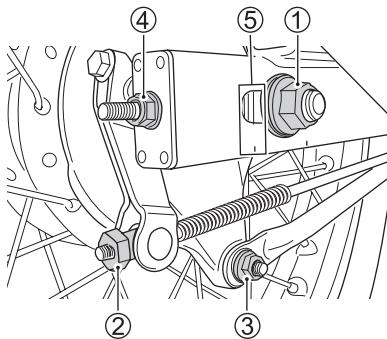

2. Loosen the axle nut ①.
3. Loosen the rear brake adjuster nut ② and rear torque link nut ③.
4. Loosen the right and left chain adjuster nuts ④.

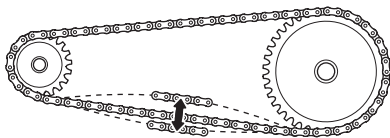

20 - 30 mm

5. Adjust the right and left chain adjuster nuts ④ until the chain has 20 - 30 mm of slack halfway between the engine sprocket and rear sprocket.
6. At the same time that the chain is being adjusted, the rear sprocket must be kept in perfect alignment with the front sprocket. To assist you in performing this procedure, there are reference marks ⑤ on the swingarm and notches on each chain adjuster which are to be aligned with each other and to be used as a reference from one side to the other.

7. Tighten the axle nut ① to specified torque.
8. Recheck the chain slack after tightening and readjust if necessary.
9. Tighten the chain adjuster nuts ④.
10. Tighten the rear torque link nut ③ to specified torque.
11. Readjust the rear brake pedal free travel by referring to the **REAR BRAKE PEDAL ADJUSTMENT** section.

Rear axle nut tightening torque:
54 N·m (5.4 kgf-m, 39.0 lbf-ft)

Rear torque link nut tightening torque:
16 N·m (1.6 kgf-m, 11.5 lbf-ft)

BRAKES

Properly operating brake systems is vital to safe riding. Be sure to perform the brake inspection as scheduled. The brakes should be inspected at periodic inspection by your authorized Suzuki dealer.

BRAKE SYSTEM

WARNING

Failure to properly inspect and maintain your motorcycle's brake systems can increase your chance of having an accident.

Be sure to inspect the brakes before each use according to the INSPECTION BEFORE RIDING section. Always maintain your brakes according to the MAINTENANCE SCHEDULE.

Inspect your brake system for the following items daily:

- Inspect the front brake system for signs of fluid leakage.
- Inspect the brake hose for leakage or a cracked appearance.
- Check the wear of the disk brake pads and brake shoe.
- The brake lever should have the proper stroke and be firm at all times.

BRAKE HOSE INSPECTION

Inspect the brake hoses and hose joints for cracks, damage or brake fluid leakage. If any defects are found, ask your Suzuki dealer to replace the brake hose with a new one.

FRONT BRAKE

BRAKE FLUID

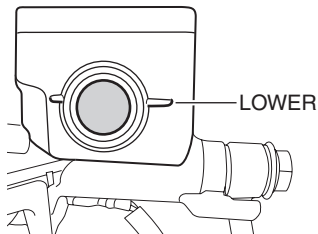

Check the brake fluid level in the front reservoir. If the level in reservoir is below the lower mark, inspect for brake pad wear and leaks.

⚠ WARNING

Brake fluid will gradually absorb moisture through the brake hoses. Brake fluid with high water content lowers the boiling point and can cause brake system malfunction due to corrosion of brake components. Boiling brake fluid or brake system malfunction could result in an accident.

Replace the brake fluid every two years to maintain braking performance.

WARNING

The use of any fluid except DOT3 or DOT4 brake fluid from a sealed container can damage the brake system and lead to an accident.

Clean filler cap before removing. Use only DOT3 or DOT4 brake fluid from a sealed container. Never use or mix with different types of brake fluid.

WARNING

Brake fluid is harmful or fatal if swallowed, and harmful if it comes in contact with skin or eyes. Solution can be poisonous to animals.

If brake fluid is swallowed, do not induce vomiting. Immediately contact a poison control center or a physician. If brake fluid gets in eyes, flush eyes with water and seek medical attention. Wash thoroughly after handling. Keep out of the reach of children and animals.

NOTICE

Spilled brake fluid can damage painted surfaces and plastic parts.

Be careful not to spill any fluid when filling the brake fluid reservoir. Wipe spilled fluid up immediately.

BRAKE PAD

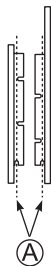
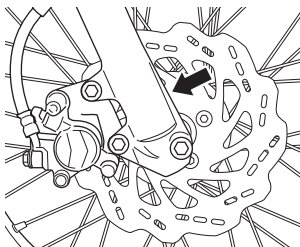

Inspect the front brake pads by noting whether or not the friction pads are worn down to the grooved wear limit line (A). If a pad is worn to the grooved wear limit line, it must be replaced with a new one by your authorized Suzuki dealer or a qualified service mechanic.

⚠ WARNING

Failure to inspect and maintain the brake pads and replace them when recommended can increase your chance of having an accident.

If you need to replace brake pads, have your Suzuki dealer do this work. Inspect and maintain the brake pads as recommended.

WARNING

If you ride this motorcycle after brake system repair or brake pad replacement without pumping the brake lever, you may get poor braking performance which could result in an accident.

After brake system repair or brake pad replacement, pump the brake lever several times until brake pads are pressed against the brake disks and proper lever stroke and firm feel are restored.

NOTE: Do not squeeze the brake lever when the pads are not in their positions. It is difficult to push the pistons back and brake fluid leakage may result.

WARNING

Replacing only one of the two brake pads can result in uneven braking action and can increase your chance of having an accident.

Always replace both pads together.

REAR BRAKE

REAR BRAKE PEDAL ADJUSTMENT

⚠ WARNING

Too much play in the rear brake pedal can cause poor braking performance and may lead to an accident. Too little play may force brake shoes to rub against the drum at all times, causing damage to the shoes and the drum.

Follow the steps in this section to adjust the rear brake pedal properly.

The rear brake pedal position and the free travel must be properly adjusted. Adjust the brake pedal in the following manner:

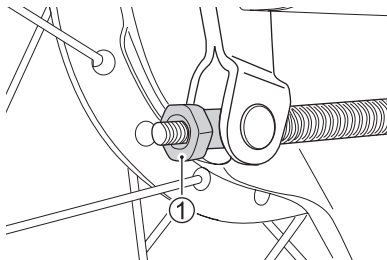
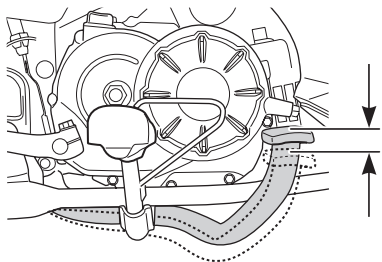

Adjust the free travel to 20 – 30 mm by turning in or out the brake adjusting nut ①.

BRAKE LINING WEAR LIMIT

The motorcycle is equipped with the brake lining wear limit indicator. To check wear of the brake lining perform the following:

1. Check if the brake system is properly adjusted.

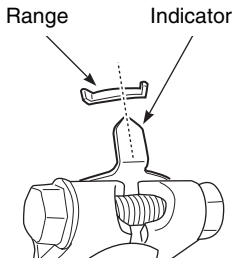

Fig.A The extension line of the indicator is within the range.

2. While fully applying the brake, check to see that the extension line of the indicator is within the range on the brake panel as shown in the figure A.

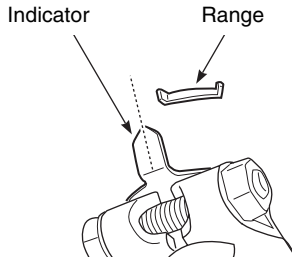

Fig.B The extension line of the indicator is out of the range.

3. If the extension line is beyond the range as shown in the figure B have the brake shoe assembly replaced by your Suzuki dealer to ensure safe operation.

⚠ WARNING

Riding with worn brake shoes will reduce braking performance and will increase your chance of having an accident.

Inspect brake shoe wear before each use. Ask your Suzuki dealer or a qualified mechanic to replace brake shoes if the shoes are worn to the limit.

REAR BRAKE LIGHT SWITCH

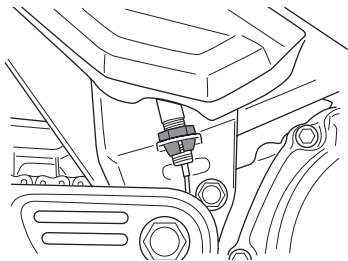

To adjust the brake light switch, hold the switch body and turn the adjuster so that the brake light will come on just before a pressure rise is felt when the brake pedal is depressed.

SPOKE NIPPLE TIGHTNESS

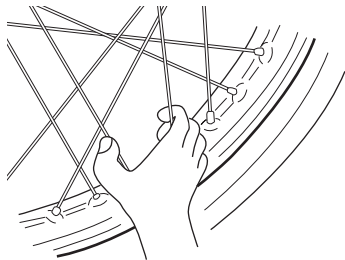

Check the tension of spokes to verify the tightness of the spoke nipples. The tension of the spokes can be checked by squeezing the spokes with your fingers. If a spoke nipple is loose, the spoke will bend more than the others. The tension can also be checked by hitting the spoke with a small metal bar. If the spoke nipple is loose, its sound will be dull.

To tighten the spoke nipples properly, tighten them equally to the specified torque. Loosened and overtightened spoke nipples may cause unequal tension of spokes and may result in distortion of the wheel rim. Contact your Suzuki dealer for this service to be performed.

TIRES

WARNING

The tires on your motorcycle form the crucial link between your motorcycle and the road. Failure to take the precautions below may result in an accident due to tire failure.

- Check tire condition and pressure before each ride, and adjust pressure if necessary.
- Avoid overloading your motorcycle.
- Replace a tire when worn to the specified limit, or if you find damage such as cuts or cracks.
- Always use the size and type of tires specified in this owner's manual.
- Read this section of the owner's manual carefully.

WARNING

Failure to perform break-in of the tires could cause tire slip and loss of control, which could result in an accident.

Use extra care when riding on new tires. Perform proper break-in of the tires referring to the **BREAK-IN** section of this manual and avoid hard acceleration, hard cornering, and hard braking for the first 160 km.

TIRE PRESSURE AND LOADING

Proper tire pressure and proper tire loading are important factors. Overloading your tires can lead to tire failure and loss of motorcycle control.

Check tire pressure each day before you ride, and adjust tire pressure and be sure the pressure is correct for the motorcycle load according to the table as follows. Tire pressure should only be checked and adjusted before riding, since riding will heat up the tires and lead to higher inflation pressure readings.

Cold Tire Inflation Pressure

	SOLO RIDING	DUAL RIDING
FRONT	175 kPa 1.75 kgf/cm ² 25 psi	175 kPa 1.75 kgf/cm ² 25 psi
REAR	225 kPa 2.25 kgf/cm ² 33 psi	280 kPa 2.80 kgf/cm ² 41 psi

Under-inflated tires make smooth cornering difficult, and can result in rapid tire wear. Over-inflated tires cause a smaller amount of tire to be in contact with the road, which can contribute to skidding and loss of control.

TIRE CONDITION AND TYPE

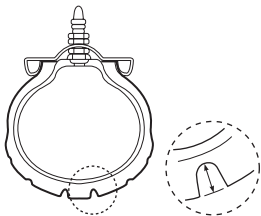

Proper the condition of your tires and proper tire type affect motorcycle performance. Cuts or cracks in the tires can lead to tire failure and loss of motorcycle control. Worn tires are susceptible to puncture failures and subsequent loss of motorcycle control. Tire wear also affects the tire profile, changing motorcycle handling characteristics.

Check the condition of your tires each day before you ride. Replace tires if tires show visual evidence of damage, such as cracks or cuts, or if tread depth is less than 1.6 mm front, 1.6 mm rear.

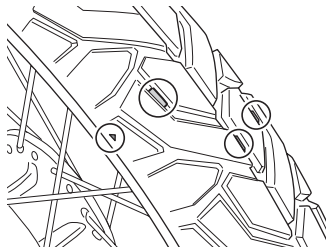

NOTE: The “Δ” mark indicates the place where the wear bars are molded into the tire. When the wear bars contact the road, it indicates that the tire wear limit has been reached.

Whenever you replace a tire, use a tire of the size and type listed below. If you use a different size or type of tire, vehicle handling may be adversely affected, possibly resulting in loss of vehicle control.

	FRONT	REAR
SIZE	70/90-17M/C 38P	80/90-17M/C 50P
TYPE	MBP STAR MP-231	MBP STAR MP-232

WARNING

An improperly repaired or installed tire can cause loss of control and an accident, or can wear out sooner.

- **Ask your Suzuki dealer or a qualified mechanic to perform tire repair and replacement because proper tools and experience are required.**
- **Install tires according to the rotation direction shown by arrows on the sidewall of each tire.**

LIGHT BULB REPLACEMENT

The wattage rating of each bulb is shown on the chart below. When replacing a burned out bulb, always use the exact same wattage rating. Using other than the specified rating can result in overloading the electrical system or premature failure of a bulb.

NOTICE

Failure to use a light bulb with the correct wattage rating can overload the electrical system of your motorcycle or cause the bulb to burn out sooner.

Use only the light bulbs shown in the chart as replacement bulbs.

Headlight	12V 32/32W
Front turn signal light	12V 10W × 2
Rear turn signal light	12V 10W × 2
Brake light/Taillight	12V 18/5W

HEADLIGHT

To replace the headlight bulb follow the procedure below:

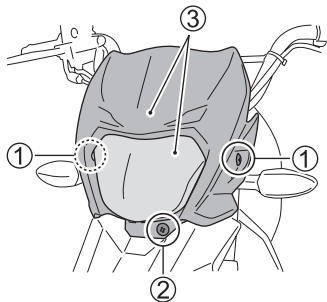

1. Remove the screws ① and ②. Remove the headlight assembly ③.

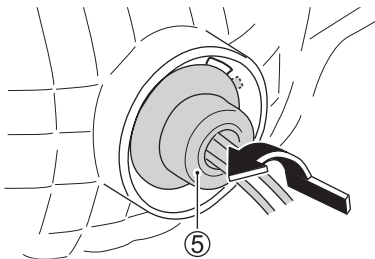
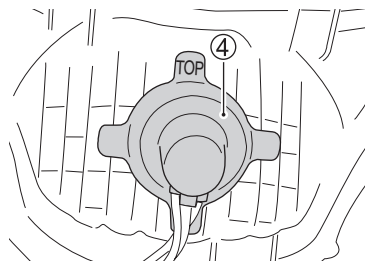

2. Remove the rubber cap ④. Push in on the socket ⑤, twisting it to the left, and pull it out.

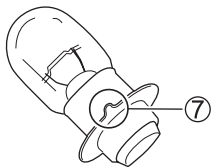
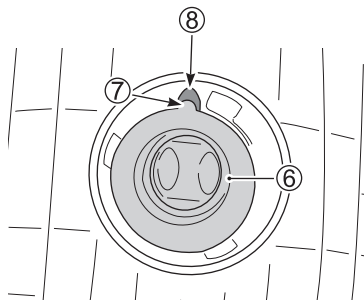

3. Pull out the bulb ⑥.
4. Fit the new bulb.
5. To reinstall the headlight, reverse the sequence described above.

NOTICE

The headlight bulb's life may be shortened by oil from your fingers if you touch it.

When replacing the headlight bulb, be careful not to touch the glass. Grasp the new bulb with a clean cloth.

NOTE: Fit the bulb projection ⑦ to the bulb holder groove ⑧.

Headlight Beam Adjustment

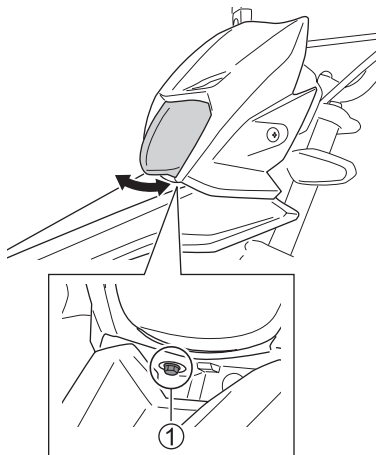

The headlight beam can be adjusted up and down if necessary. Loosen the headlight beam adjuster bolt ①. To adjust the beam, move the headlight forward or backward.

TURN SIGNAL LIGHT

To replace the turn signal light bulb, follow the procedure below.

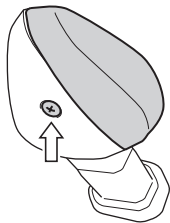

1. Remove the screw and lens.

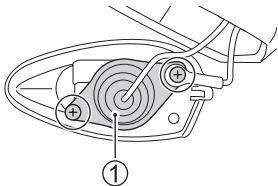

2. Remove the screws and take off the socket ①.

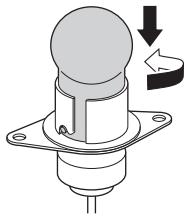

3. Push in on the bulb, twisting it to the left, and pull it out.
4. To fit the replacement bulb, push it in and twist it to the right while pushing.

REAR TURN SIGNAL LIGHT AND BRAKE LIGHT/TAILLIGHT

To replace the rear turn signal light and brake light/taillight bulb, follow the procedure below:

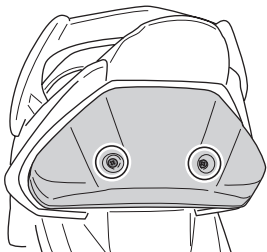

1. Remove the screws.

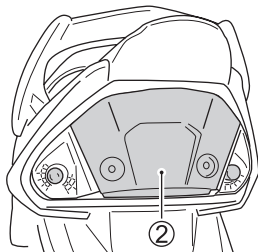
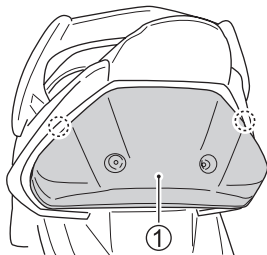

2. Unhook the hooks and remove the lenses ① and ②.

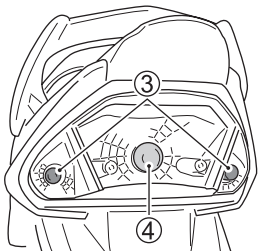

Rear turn signal light bulb

3. Pull off the rear turn signal lights bulb ③ from the socket.
4. Fit the new bulb.

Brake light/Taillight bulb

3. Push in on the brake light/taillight bulb ④, turn it to the left, and pull it out.
4. To fit the replacement bulb, push it in and twist it to the right while pushing.

NOTICE

Overtightening the screws when reinstalling the lens may cause the lens to crack.

Tighten the screws only until they are snug.

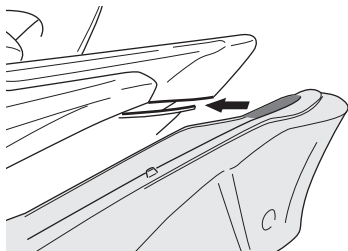

Insert the lens referring to the illustration.

FUSE

If something electrical on your motorcycle stops working, the first thing you should check for is a blown fuse. The electrical circuits on the motorcycle are protected from overload by fuses in the circuits.

If a blown fuse is found, then the electrical problem must be inspected and repaired before replacing the blown fuse with a new fuse. Consult your Suzuki dealer for the electrical system check and repair.

WARNING

Replacing a fuse with a fuse that has an incorrect amperage rating or substitute, e.g. aluminum foil or wire, may cause serious damage to the electrical system and possibly fire. Always replace a blown fuse with a fuse of the same amperage rating.

If the new fuse blows in a short time, the electrical problem may not be fixed. Have your motorcycle inspected immediately by your Suzuki dealer.

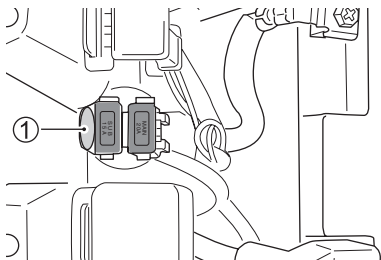

The MAIN and SUB fuses are located in the battery box. The MAIN (20A) and SUB (15A) fuses are equipped. It is designed to open when a circuit overload exists in individual electrical system circuits. If any electrical system fails to operate, then the fuse must be checked. To check the fuse, remove the battery box lid. The spare fuses ① are provided in the vinyl case.

CATALYTIC CONVERTER

The purpose of the catalytic converter is to minimize the amount of harmful pollutants in your motorcycle's exhaust. Use of leaded fuel in motorcycles equipped with catalytic converters is prohibited because lead deactivates the pollutant-reducing components of the catalyst system.

The converter is designed to last the life of the motorcycle under normal usage and when unleaded fuel is used. Not special maintenance is required on the converter. However, it is very important to keep the engine properly tuned. Engine misfiring, which can result from an improperly tuned engine, may cause overheating of the catalyst. This may result in permanent heat damage to the catalyst and other motorcycle components.

WARNING

If you park or operate the motorcycle in areas where there are combustible materials such as dry grass or leaves, these materials may come in contact with the catalytic converter or other hot exhaust components. This can cause a fire.

Avoid parking or operating your motorcycle in areas with any combustible materials.

NOTICE

Improper motorcycle operation can cause catalyst or other motorcycle damage.

To avoid damage to the catalyst or other related components, you should take the following precautions:

- Maintain the engine in the proper operating condition.
- In the event of an engine malfunction, particularly one involving engine misfire or other apparent performance loss, stop riding the motorcycle and turn off the engine and have the motorcycle serviced promptly.
- Do not shut off the engine or interrupt the ignition when the transmission is in gear and the motorcycle is in motion.

- Do not try to start the engine by pushing the motorcycle or by coasting down a hill.
- Do not idle the engine with any spark plug wires disconnected or removed, such as during diagnostic testing.
- Do not idle the motorcycle for prolonged periods if idling seems rough or there are other malfunctions.
- Do not allow the fuel tank to get near the empty level.



TROUBLESHOOTING

FUEL SUPPLY CHECK	7-2
IGNITION SYSTEM CHECK	7-3
ENGINE STALLING	7-3

TROUBLESHOOTING

This troubleshooting guide is provided to help you find the cause of some common complaints.

NOTICE

Improper repairs or adjustments may damage the motorcycle instead of fixing it. Such damage may not be covered under warranty.

If you are not sure about the proper action, consult your Suzuki dealer about the problem.

If the engine refuses to start, perform the following inspections to determine the cause.

FUEL SUPPLY CHECK

If the malfunction indicator light comes on, showing signs of trouble in the fuel injection system, take your machine to an authorized Suzuki dealer. Refer to the "INSTRUMENT PANEL" section for an explanation of malfunction indicator light.

IGNITION SYSTEM CHECK

1. Remove the spark plug and reattach it to the spark plug cap.
2. While holding the spark plug firmly against the engine, crank the engine with the ignition switch in the "ON" position. If the ignition system is operating properly, a blue spark should jump across the spark plug gap. If there is no spark, consult your Suzuki dealer for repairs.

WARNING

Performing the spark test improperly can be hazardous. You could get a high voltage electrical shock if you are not familiar with this procedure.

Do not perform this check if you are not familiar with the procedure. Do not point the spark plug near the spark plug hole during this test. Do not perform this test if you have a heart condition or wear a pacemaker.

ENGINE STALLING

1. Make sure there is enough fuel in the fuel tank.
2. If the malfunction indicator light comes on, showing signs of trouble in the fuel injection system, take your machine to an authorized Suzuki dealer. Refer to the "INSTRUMENT PANEL" section for an explanation of the malfunction indicator light
3. Check the ignition system for intermittent spark.
4. Check the idle speed. The correct idle speed is 1300 – 1500 r/min.



STORAGE PROCEDURE AND MOTORCYCLE CLEANING

STORAGE PROCEDURE	8-2
PROCEDURE FOR RETURNING TO SERVICE	8-3
CORROSION PREVENTION	8-4
MOTORCYCLE CLEANING	8-5
INSPECTION AFTER CLEANING	8-8

STORAGE PROCEDURE AND MOTORCYCLE CLEANING

STORAGE PROCEDURE

If the motorcycle is to be left unused for an extended period of time for winter storage or any other reason, the machine needs special servicing requiring appropriate materials, equipment and skill. For this reason, Suzuki recommends that you trust this maintenance work to your Suzuki dealer. If you need to service the machine for storage yourself, follow the general guidelines below.

MOTORCYCLE

Clean the entire motorcycle. Place the motorcycle on the center stand on a firm, flat surface where it will not fall over. Turn the handlebars all the way to the left and lock the steering, and remove the ignition key.

FUEL

1. Fill the fuel tank to the top with fuel mixed with the amount of gasoline stabilizer recommended by the stabilizer manufacturer.
2. Run the engine for a few minutes until the stabilized gasoline fills the fuel injection system.

BATTERY

1. Remove the battery from the motorcycle by referring to the BATTERY section.
2. Clean the outside of the battery with a mild detergent and remove any corrosion from the terminals and wiring harness connections.
3. Store the battery in a room above freezing.

TIRES

Inflate the tires to the normal specifications.

EXTERNAL

- Spray all vinyl and rubber parts with rubber preservative.
- Spray the unpainted surfaces with rust preventative.
- Coat the painted surfaces with car wax.

MAINTENANCE DURING STORAGE

Once a month, recharge the battery by referring to the BATTERY section. If you cannot charge the battery, consult your authorized Suzuki dealer.

PROCEDURE FOR RETURNING TO SERVICE

- Clean the entire motorcycle.
- Reinstall the battery by referring to the BATTERY section.
- Adjust the pressure of tires as described in the TIRE section.
- Lubricate all places as instructed in this manual.
- Do the “INSPECTION BEFORE RIDING” as listed in this manual.

CORROSION PREVENTION

It is important to take good care of your motorcycle to protect it from corrosion and keep it looking new for years to come.

Important Information About Corrosion

Common causes of corrosion

- Accumulation of road salt, dirt, moisture, or chemicals in hard-to-reach areas.
- Chipping, scratches, and any damage to treated or painted metal surfaces resulting from minor accidents or impacts from stones and gravel.

Road salt, sea air, industrial pollution, and high humidity will all contribute to corrosion.

How to Help Prevent Corrosion

- Wash your motorcycle frequently, at least once a month. Keep your motorcycle as clean and dry as possible.
- Remove foreign material deposits. Foreign material such as road salt, chemicals, road oil or tar, tree sap, bird droppings and industrial fall-out may damage your motorcycle's finish. Remove these types of deposits as quickly as possible. If these deposits are difficult to wash off, an additional cleaner may be required. Follow the manufacturer's directions when using these special cleaners.
- Repair finish damage as soon as possible. Carefully examine your motorcycle for damage to the painted surfaces. Should you find any chips or scratches in the paint, touch them up immediately to prevent corrosion from starting. If the chips or scratches have gone through to the bare metal, have a Suzuki dealer make the repair.

- Store your motorcycle in a dry, well-ventilated area. If you often wash your motorcycle in the garage or if you frequently park it inside when wet, your garage may be damp. The high humidity may cause or accelerate corrosion. A wet motorcycle may corrode even in a heated garage if the ventilation is poor.
- Cover your motorcycle. Exposure to mid-day sun can cause the colors in paint, plastic parts, and instrument faces to fade. Covering your motorcycle with a high-quality, “breathable” motorcycle cover can help protect the finish from the harmful UV rays in sunlight, and can reduce the amount of dust and air pollution reaching the surface. Your Suzuki dealer can help you select the right cover for your motorcycle.

MOTORCYCLE CLEANING

WASHING THE MOTORCYCLE

When washing the motorcycle, follow the instructions below:

1. Remove dirt and mud from the motorcycle with cool running water. You may use a soft sponge or brush. Do not use hard materials which can scratch the paint.
2. Wash the entire motorcycle with a mild detergent or car wash soap using a sponge or soft cloth. The sponge or cloth should be frequently soaked in the soap solution.

NOTE: Clean the motorcycle with cool water immediately after riding on road salt or riding along the coast. Be sure to use cool water because warm water can hasten corrosion.

NOTE: Avoid spraying or allowing water to flow over the following places:

- *Ignition switch*
- *Spark plug*
- *Fuel tank cap*
- *Throttle body*
- *Fuel injection system*
- *Brake master cylinder*
- *Throttle cable boots*

NOTICE

High pressure washers such as those found at coin-operated car washes have enough pressure to damage the parts of your motorcycle. It may cause rust, corrosion and increase wear. Parts cleaner can also damage motorcycle parts.

Do not use high pressure washers to clean your motorcycle. Do not use parts cleaner on throttle body and electric parts.

3. Once the dirt has been completely removed, rinse off the detergent with running water.
4. After rinsing, wipe off the motorcycle with a wet chamois or cloth and allow it to dry in the shade.
5. Check carefully for damage to painted surfaces. If there is any damage, obtain “touch-up” paint and “touch-up” the damage following the procedure below:
 - a. Clean all damaged spots and allow them to dry.
 - b. Stir the paint and “touch-up” the damaged spots lightly with a small brush.
 - c. Allow the paint to dry completely.

NOTE: The headlight lens can be fogged after washing the motorcycle or riding in the rain. Headlight fogging will be cleared gradually when the headlight is turned on. When clearing the headlight lens fogging, run the engine to avoid battery discharge.

NOTICE

Cleaning your motorcycle with any alkaline or strong acid cleaner, gasoline, brake fluid, or any other solvent will damage the motorcycle parts.

Clean only with soft cloth and warm water with mild detergent.

PLASTIC PARTS

Plastic parts such as headlight lens, speedometer display, are easy to be damaged. When such part is cleaned, wash it using water after cleaning it using neutral detergent or soapy water, and wipe it with a soft cloth.

NOTICE

When any of the following substances is attached to the plastic part such as headlight lens or speedometer display, it might cause a scratch or damage to the part.

- Wax compound
- Chemical supplies such as oil film removing agent or repellents
- Acidic or alkaline detergent
- Brake fluid, gasoline or organic solvent, etc.

WAXING THE MOTORCYCLE

After washing the motorcycle, waxing and polishing are recommended to further protect and beautify the paint.

- Only use waxes and polishes of good quality.
- When using waxes and polishes, observe the precautions specified by the manufacturers.

SPECIAL CARE FOR MATTE FINISH PAINT

Do not use polishing compounds or waxes that contain polishing compounds on surfaces which have a matte finish. The use of polishing compounds will change the appearance of the matte finish.

Solid type waxes may be difficult to remove from surfaces with a matte finish.

Friction while riding, excessive rubbing or polishing of a surface with a matte finish will change its appearance.

INSPECTION AFTER CLEANING

For extended life of your motorcycle, lubricate it according to the “LUBRICATION POINTS” section.

WARNING

Operating the motorcycle with wet brakes can be hazardous. Wet brakes may not provide as much stopping power as dry brakes. This could lead to an accident.

Test your brakes after washing the motorcycle, while riding at slow speed. If necessary, apply the brakes several times to let friction dry out the linings.

Follow the procedures in the “INSPECTION BEFORE RIDING” section to check your motorcycle for any problems that may have arisen during your last ride.



SPECIFICATIONS

DIMENSIONS AND CURB MASS

Overall length	1970 mm
Overall width	810 mm
Overall height	1045 mm
Wheelbase	1225 mm
Ground clearance	155 mm
Curb mass	98 kg

ENGINE

Type	4-stroke, air-cooled, OHC
Number of cylinders	1
Bore	51.0 mm
Stroke	55.2 mm
Displacement	113 cm ³
Corrected compression ratio	9.3 : 1
Fuel system	Fuel injection
Air cleaner	Paper element
Starter system	Electric and kick
Lubrication system	Wet sump

DRIVE TRAIN

Clutch	Wet shoe, automatic, centrifugal type
Transmission	4-speed
Gearshift pattern	All down
Primary reduction ratio	3.285 (69/21)
Gear ratios, Low	3.000 (33/11)
2nd	1.812 (29/16)
3rd	1.368 (26/19)
Top	1.095 (23/21)
Final reduction ratio	2.642 (37/14)
Drive chain	RK420SL, 102 links

CHASSIS

Front suspension	Telescopic, coil spring, oil damped
Rear suspension	Swingarm type, coil spring, oil damped
Front suspension stroke	90 mm
Rear wheel travel	81 mm
Steering angle	45° (right and left)
Turning radius	1.9 m
Front brake	Disk brake
Rear brake	Drum brake
Front tire size	70/90-17M/C 38P, tube type
Rear tire size	80/90-17M/C 50P, tube type

ELECTRICAL

Ignition type	Electronic ignition (Transistorized)
Spark plug	NGK CPR7EA-9 or DENSO U22EPR9
Battery	12V 10.8 kC(3 Ah)/10HR
Generator	Single-phase A.C.generator
Main fuse	20A
Sub fuse	15A
Headlight	12V 32/32W
Brake light/Taillight.....	12V 18/5W
Front turn signal light	12V 10W × 2
Rear turn signal light	12V 10W × 2
Speedometer light	12V 1.7W × 2
High beam indicator light.....	12V 1.7W
Turn signal indicator light.....	12V 1.7W
Top gear position indicator light.....	12V 1.7W
Neutral indicator light.....	12V 1.7W
Malfunction indicator light.....	12V 1.7W

CAPACITIES

Fuel tank.....	4.0 L
Engine oil, oil change	650 ml
With filter change	800 ml
Overhaul.....	1000 ml



INDEX

A

- ACCESSORY INSTALLATION AND PRECAUTION SAFETY TIPS 1-2
- AIR CLEANER..... 6-14
- AVOID CONSTANT LOW SPEED 4-3

B

- BATTERY 6-7
- BRAKES 6-37
- BREAKING IN THE NEW TIRES 4-3

C

- CATALYTIC CONVERTER 6-58
- CORROSION PREVENTION 8-4

D

- DRIVE CHAIN..... 6-31

E

- ENGINE OIL 3-4, 6-25
- ENGINE STALLING..... 7-3

F

- FRONT BRAKE 6-38
- FUEL 3-2
- FUEL HOSE 6-21
- FUEL SUPPLY CHECK..... 7-2
- FUEL TANK CAP 2-13
- FUSE 6-57

G

- GEARSHIFT LEVER 2-16

I

- IDLE SPEED ADJUSTMENT 6-19
- IGNITION SWITCH 2-6
- IGNITION SYSTEM CHECK 7-3
- INSPECTION AFTER CLEANING 8-8
- INSPECTION BEFORE RIDING 4-4
- INSTRUMENT PANEL 2-8

K

- KEY.....2-5
- KICK STARTER LEVER.....2-15

L

- LABELS 1-7
- LEFT HANDLEBAR.....2-10
- LIGHT BULB REPLACEMENT6-50
- LOCATION OF PARTS2-2
- LUBRICATION POINTS6-5
- LUGGAGE BOX2-19

M

- MAINTENANCE SCHEDULE6-2
- MAXIMUM THROTTLE OPERATION
RECOMMENDATION.....4-2
- MODIFICATION.....1-7
- MOTORCYCLE CLEANING8-5

O

- OBSERVE YOUR FIRST AND MOST
CRITICAL SERVICE 4-4
- OXYGENATED FUEL
RECOMMENDATION.....3-2

P

- PROCEDURE FOR RETURNING TO
SERVICE.....8-3

R

- REAR BRAKE6-42
 - REAR BRAKE PEDAL.....2-17
 - RIDING ON HILLS.....5-6
 - RIGHT HANDLEBAR2-12
- 

S

SAFE RIDING RECOMMENDATION FOR MOTORCYCLE RIDERS.....	1-5
SEAT LOCK AND HELMET HOLDER	2-17
SERIAL NUMBER LOCATION	1-8
SPARK PLUG.....	6-11
SPOKE NIPPLE TIGHTNESS	6-45
STANDS	2-20
STARTING OFF	5-3
STARTING THE ENGINE.....	5-2
STOPPING AND PARKING	5-6
STORAGE PROCEDURE	8-2

T

THROTTLE CABLE PLAY	6-20
TIRES	6-46
TOOLS.....	6-5

U

USING THE TRANSMISSION.....	5-5
-----------------------------	-----

V

VARY THE ENGINE SPEED.....	4-2
----------------------------	-----



Warranty System



WARRANTY COVERAGE

FOR ALL MODELS

24 months or 20,000km
whichever comes first

EXPENDABLE PARTS NOT COVERED BY WARRANTY

- Spark plugs
- Lamp bulbs
- Fuses
- Rubber parts except engine oil seals
- Bolts, nuts, washers
- Brake / clutch linings
- Cables
- Gaskets
- Tires and inner tubes
- Mags
- Spokes
- Sprockets (Engine and wheel)
- Drive chain / V-belt

CONDITIONS NOT COVERED BY WARRANTY

- Units that have not undergone required periodic inspection.
- Units serviced by mechanics not authorized by Suzuki.
- Units damaged by use of parts other than Suzuki Genuine Parts.
- Damages caused by users negligence or abuse.
- Delivery or transport problems.
- Changes or alterations in the unit not recommended by Suzuki.
- Accidents, collisions, over-revolution of engine, racing...
- Use of fuel and oil not recommended by Suzuki.
- Trouble caused by breaking a seal or disassembling any unremovable parts such as ECM, CDI unit, switches, speedometer, oil pump, fuel pump, etc.
- Trouble caused by inappropriate care (Rusting, fading of color, natural deterioration, etc.)

SERVICE RECORD

Reliability and performance depend on the special care and maintenance of your motorcycle. Visit your dealers for Periodic Maintenance Service when your motorcycle has reached the specified number of month/s or kilometer reading (whichever comes first) as shown below.

Owner's Name				Dealer Name	
Address				Address	
Model		Color		Date Purchased	
Eng No.				Frame No.	

1st Month (1,000 km) Service						
Service Date			Km Reading		JO No.	
Servicing Dealer / Address						
Mechanic Name / Signature			Customer Name / Signature			
Replaced Oil?	<input type="checkbox"/> YES <input type="checkbox"/> NO		Replaced Oil filter?	<input type="checkbox"/> YES <input type="checkbox"/> NO	If YES what oil brand?	

4th Month (4,000 km) Service

Service Date		Km Reading		JO No.	
Servicing Dealer / Address					
Mechanic Name / Signature		Customer Name / Signature			
Replaced Oil?	<input type="checkbox"/> YES <input type="checkbox"/> NO	Replaced Oil filter?	<input type="checkbox"/> YES <input type="checkbox"/> NO	If YES what oil brand?	

8th Month (8,000 km) Service

Service Date		Km Reading		JO No.	
Servicing Dealer / Address					
Mechanic Name / Signature		Customer Name / Signature			
Replaced Oil?	<input type="checkbox"/> YES <input type="checkbox"/> NO	Replaced Oil filter?	<input type="checkbox"/> YES <input type="checkbox"/> NO	If YES what oil brand?	

12th Month (12,000 km) Service

Service Date		Km Reading		JO No.	
Servicing Dealer / Address					
Mechanic Name / Signature		Customer Name / Signature			
Replaced Oil?	<input type="checkbox"/> YES <input type="checkbox"/> NO	Replaced Oil filter?	<input type="checkbox"/> YES <input type="checkbox"/> NO	If YES what oil brand?	

16th Month (16,000 km) Service

Service Date		Km Reading		JO No.	
Servicing Dealer / Address					
Mechanic Name / Signature		Customer Name / Signature			
Replaced Oil?	<input type="checkbox"/> YES <input type="checkbox"/> NO	Replaced Oil filter?	<input type="checkbox"/> YES <input type="checkbox"/> NO	If YES what oil brand?	

24th Month (20,000 km) Service

Service Date		Km Reading		JO No.	
Servicing Dealer / Address					
Mechanic Name / Signature		Customer Name / Signature			
Replaced Oil?	<input type="checkbox"/> YES <input type="checkbox"/> NO	Replaced Oil filter?	<input type="checkbox"/> YES <input type="checkbox"/> NO	If YES what oil brand?	





SUZUKI PHILIPPINES, INCORPORATED

126 Progress Avenue, Carmelray Industrial Park 1,
Carmelton, Canlubang, Calamba City 4028, Laguna

WEBSITE: <http://www.suzuki.com.ph>

Part No. 99011C09L52L31A

December 2021



Printed in the Philippines