



# **UX110NE/NER**

---

**OWNER'S MANUAL**

**This manual should be considered a permanent part of the motorcycle and should remain with the motorcycle when resold or otherwise transferred to a new owner or operator. The manual contains important safety information and instructions which should be read carefully before operating the motorcycle.**

## IMPORTANT

### **BREAK-IN (RUNNING-IN) INFORMATION FOR YOUR MOTORCYCLE**

The first 1600 km are the most important in the life of your motorcycle. Proper break-in operation during this time will help ensure maximum life and performance from your new motorcycle. Suzuki parts are manufactured of high quality materials, and machined parts are finished to close tolerances. Proper break-in operation allows the machined surfaces to polish each other and mate smoothly.

Motorcycle reliability and performance depend on special care and restraint exercised during the break-in period. It is especially important that you avoid operating the engine in a manner which could expose the engine parts to excessive heat.

Please refer to the BREAK-IN (RUNNING-IN) section for specific break-in recommendations.

For further inquiries & concerns, feel free to contact us at:  
SUZUKI PHILIPPINES, INCORPORATED  
CUSTOMER CARE DEPARTMENT  
126 Progress Avenue, Carmelray Industrial  
Park 1, Carmelton, Canlubang, Calamba City  
4028, Laguna



**▲ WARNING/▲ CAUTION/NOTICE/NOTE**

Please read this manual and follow its instructions carefully. To emphasize special information, the symbol ▲ and the words **WARNING**, **CAUTION**, **NOTICE** and **NOTE** have special meanings. Pay particular attention to messages highlighted by these signal words:

**▲ WARNING**

Indicates a potential hazard that could result in death or serious injury.

**▲ CAUTION**

Indicates a potential hazard that could result in minor or moderate injury.

***NOTICE***

Indicates a potential hazard that could result in vehicle or equipment damage.

*NOTE: Indicates special information to make maintenance easier or instructions clearer.*

## FOREWORD

Motorcycling is one of the most exhilarating sports and to ensure your riding enjoyment, you should become thoroughly familiar with the information presented in this Owner's Manual before riding the motorcycle.

The proper care and maintenance that your motorcycle requires is outlined in this manual. By following these instructions explicitly you will ensure a long trouble free operating life for your motorcycle. Your authorized Suzuki dealer has experienced technicians that are trained to provide your machine with the best possible service with the right tools and equipment.

All information, illustrations and specifications contained in this manual are based on the latest product information available at the time of publication. Due to improvements or other changes, there may be some discrepancies between information in this manual and your motorcycle. Suzuki reserves the right to make changes at any time.

**SUZUKI PHILIPPINES, INCORPORATED**



# TABLE OF CONTENTS

<b>CONSUMER INFORMATION</b>	<b>1</b>
<b>CONTROLS</b>	<b>2</b>
<b>FUEL AND ENGINE OIL RECOMMENDATION</b>	<b>3</b>
<b>BREAK-IN (RUNNING-IN) AND INSPECTION BEFORE RIDING</b>	<b>4</b>
<b>RIDING TIPS</b>	<b>5</b>
<b>INSPECTION AND MAINTENANCE</b>	<b>6</b>
<b>TROUBLESHOOTING</b>	<b>7</b>
<b>STORAGE PROCEDURE AND MOTORCYCLE CLEANING</b>	<b>8</b>
<b>SPECIFICATIONS</b>	
<b>INDEX</b>	





# CONSUMER INFORMATION

---

ACCESSORY USE AND MOTORCYCLE LOADING .....	1-2
MODIFICATION .....	1-5
SAFE RIDING RECOMMENDATION FOR MOTORCYCLE RIDERS .....	1-5
LABELS .....	1-8
SERIAL NUMBER LOCATION .....	1-9

## CONSUMER INFORMATION

### ACCESSORY USE AND MOTORCYCLE LOADING

#### ACCESSORY USE

The addition of unsuitable accessories can lead to unsafe operating conditions. It is not possible for Suzuki to test each accessory on the market or combinations of all the available accessories; however, your dealer can assist you in selecting quality accessories and installing them correctly. Use extreme caution when selecting and installing the accessories on your motorcycle and consult your Suzuki dealer if you have any questions.

#### **WARNING**

Improper installation of accessories or modification of the motorcycle may cause changes in handling which could lead to an accident.

**Never use improper accessories, and make sure that any accessories that are used are properly installed. All parts and accessories added to the motorcycle should be genuine Suzuki parts or their equivalent designed for use on this motorcycle. Install and use them according to their instructions. If you have any questions, contact your Suzuki dealer.**

## **ACCESSORY INSTALLATION GUIDELINES**

- Install aerodynamic-affecting accessories, such as a fairing, windshield, backrests, saddlebags, and travel trunks, as low as possible, as close to the motorcycle and as near the center of gravity as is feasible. Check that the mounting brackets and other attachment hardware are rigidly mounted.
  - Inspect for proper ground clearance and bank angle. Inspect that the accessory does not interfere with the operation of the suspension, steering or other control operations.
  - Accessories fitted to the handlebars or the front fork area can create serious stability problems. This extra weight will cause the motorcycle to be less responsive to your steering control. The weight may also cause oscillations in the front end and lead to instability problems. Accessories added to the handlebars or front fork of the motorcycle should be as light as possible and kept to a minimum.
- Select an accessory which does not limit the freedom of rider movement.
  - Select an electrical accessory which does not exceed the motorcycle's electrical system capacity. Severe overloads may damage the wiring harness or create hazardous situations.
  - Do not pull a trailer or sidecar. This motorcycle is not designed to pull a trailer or sidecar.

## LOADING GUIDELINES

### **WARNING**

**Overloading or improper loading can cause loss of motorcycle control and an accident.**

**Follow loading guidelines in this manual.**

This motorcycle is primarily intended to carry small items when you are not riding with a passenger. Follow the loading guidelines below:

- Balance the load between the left and right side of the motorcycle and fasten it securely.
- Keep cargo weight low and as close to the center of the motorcycle as possible.
- Do not attach large or heavy items to the handlebars, front forks or rear fender.
- Do not install a luggage carrier or a luggage box protruding over the tail end of the motorcycle.

- Do not carry any items that protrude over the tail end of the motorcycle.
- Check that both tires are properly inflated to the specified tires pressure for your loading conditions. Refer to page 6-45.
- Improperly loading your motorcycle can reduce your ability to balance and steer the motorcycle. You should ride at reduced speeds, when you are carrying cargo or have added accessories.

## **MODIFICATION**

Modification of the motorcycle, or removal of original equipment may render the vehicle unsafe or illegal.

## **SAFE RIDING RECOMMENDATION FOR MOTORCYCLE RIDERS**

Motorcycle riding is great fun and an exciting sport. Motorcycle riding also requires that some extra precautions be taken to ensure the safety of the rider and passenger. These precautions are:

### **WEAR A HELMET**

Motorcycle safety equipment starts with a quality helmet. One of the most serious injuries that can happen is a head injury. ALWAYS wear a properly approved helmet. You should also wear suitable eye protection.

### **RIDING APPAREL**

Loose, fancy clothing can be uncomfortable and unsafe when riding your motorcycle. Choose good quality motorcycle riding apparel when riding your motorcycle.

## **INSPECTION BEFORE RIDING**

Review thoroughly the instructions in the “INSPECTION BEFORE RIDING” section of this manual. Do not forget to perform an entire safety inspection to ensure the safety of the rider and its passenger.

## **FAMILIARIZE YOURSELF WITH THE MOTORCYCLE**

Your riding skill and your mechanical knowledge form the foundation for safe riding practices. We suggest that you practice riding your motorcycle in non-traffic situation until you are thoroughly familiar with your motorcycle and its controls. Remember practice makes perfect.

## **KNOW YOUR LIMITS**

Ride within the boundaries of your own skill at all times. Knowing these limits and staying within them will help you to avoid accidents.

## **BE EXTRA SAFETY CONSCIOUS ON BAD WEATHER DAYS**

Riding on bad weather days, especially wet ones, requires extra caution. Braking distances double on a rainy day. Stay off the painted surface marks, manhole covers and greasy appearing areas as they can be especially slippery. Use extreme caution at railway crossings and on metal gratings and bridges. Whenever in doubt about road condition, slow down!

## **DO NOT RIDE YOUR MOTORCYCLE ON FLOODED ROAD**

In case you ride your motorcycle on flooded road, go slowly checking braking operation and park the motorcycle in a safe place, and have your motorcycle inspected in the following items at a Suzuki dealer.

- Braking efficiency
- Wet connector and wiring
- Drive belt slipping
- Poor lubrication for bearing etc.
- Level and quality change of gear oil (if oil is whitish, water is mixed and oil change is required)

## ***NOTICE***

**Running the motorcycle on flooded road affects engine stop, failure of electric parts, drive belt slipping and engine breakage.**

**Do not ride your motorcycle on flooded road or puddles.**

## **RIDE DEFENSIVELY**

The most common type of motorcycle accident occurs when a car traveling towards a motorcycle turns round corner in front of the motorcyclist. Ride defensively. Wise motorcyclist uses a strategy of assuming they are invisible to other drivers, even in broad daylight. Wear bright, reflecting clothing. Turn on the headlight and taillight every time even on a bright, sunny day to attract driver's attention. Do not ride in another driver's blind spot.

## **LABELS**

Read and follow all the labels on the motorcycle. Make sure you understand all of the labels. Do not remove any labels from the motorcycle.



## SERIAL NUMBER LOCATION

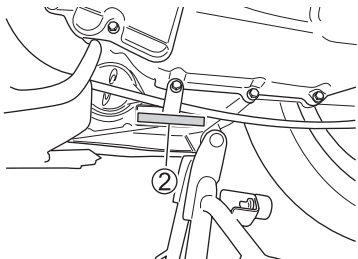
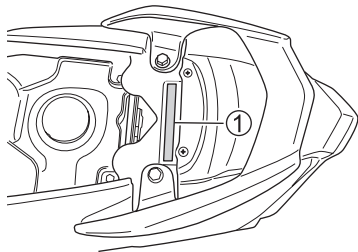

The frame and/or engine serial numbers are used to register the motorcycle. They are also used to assist your dealer when ordering parts or referring to special service information.

The frame number ① is stamped on the frame located under the seat. The engine serial number ② is stamped on the crankcase assembly.

Please write down the numbers in the box provided below for your future reference.

Frame number:

Engine number:



# CONTROLS

---

LOCATION OF PARTS .....	2-2
KEY .....	2-14
IGNITION SWITCH .....	2-14
INSTRUMENT PANEL (UX110NER) .....	2-17
INSTRUMENT PANEL (UX110NE/NZ) .....	2-26
LEFT HANDLEBAR .....	2-28
RIGHT HANDLEBAR .....	2-30
FUEL TANK CAP .....	2-32
KICK STARTER LEVER .....	2-33
SEAT LOCK AND HELMET HOLDERS .....	2-34
FRONT HOOK .....	2-35
FRONT RACKS .....	2-36
TRUNK .....	2-36
STANDS .....	2-37

# CONTROLS

## LOCATION OF PARTS

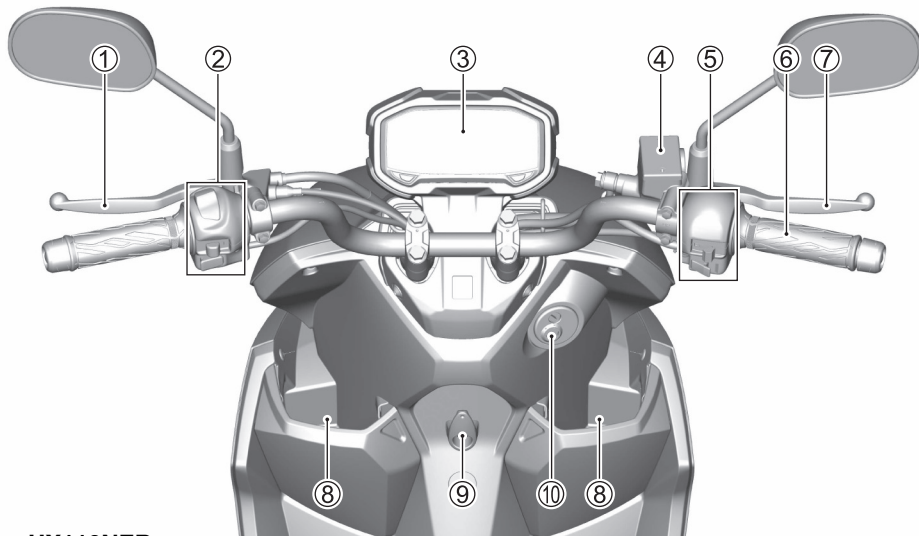

**UX110NER**

- ① Rear brake lever
- ② Left handlebar switches
- ③ Instrument panel
- ④ Front brake fluid reservoir
- ⑤ Right handlebar switches
- ⑥ Throttle grip
- ⑦ Front brake lever
- ⑧ Front racks
- ⑨ Front hook
- ⑩ Ignition switch

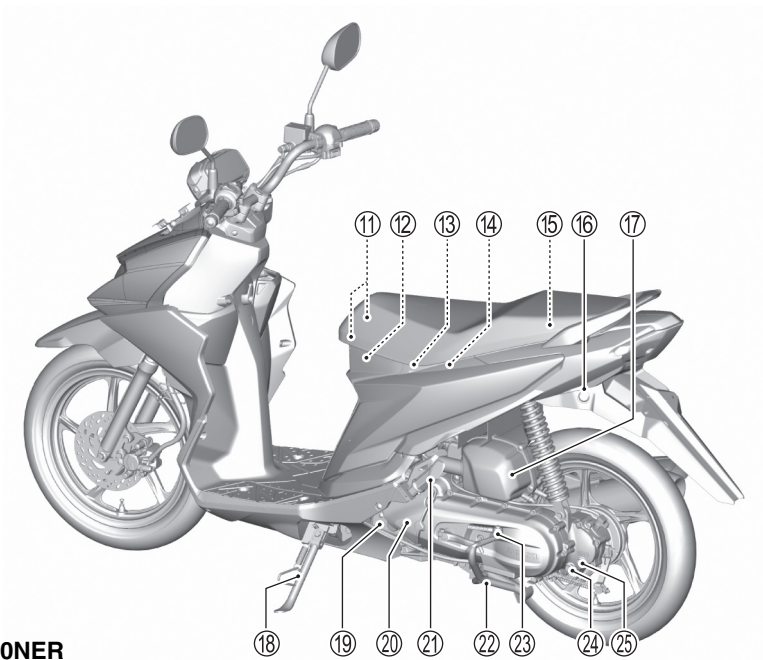

**UX110NER**

- ⑪ Helmet holders
- ⑫ Tools
- ⑬ Battery and fuses
- ⑭ Trunk
- ⑮ Fuel tank cap
- ⑯ Seat lock
- ⑰ Air cleaner
- ⑱ Side stand
- ⑲ Engine oil filter
- ⑳ Cooling fan filter
- ㉑ Passenger footrest
- ㉒ Center stand
- ㉓ Kick starter lever
- ㉔ Gear oil drain plug
- ㉕ Gear oil filler plug

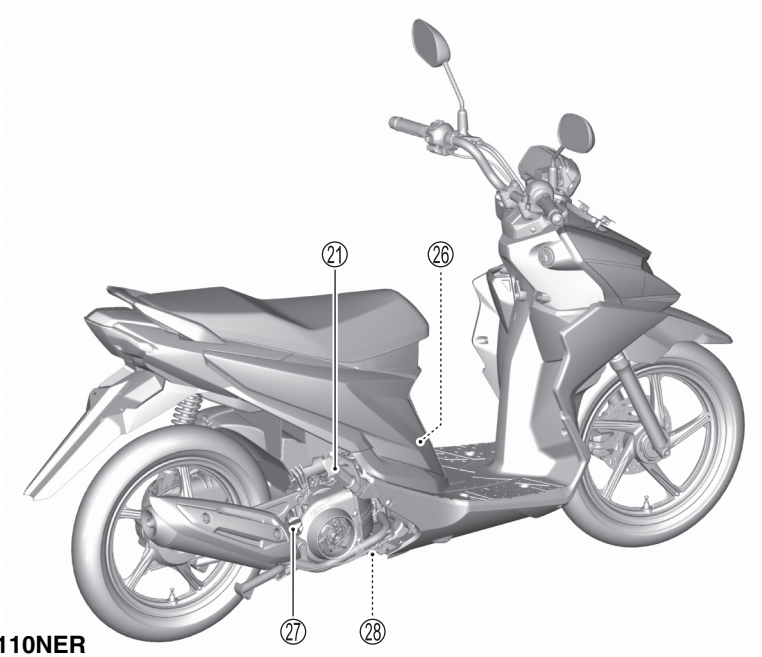

**UX110NER**



- ②⑥ Spark plug
- ②⑦ Engine oil filler cap
- ②⑧ Engine oil drain plug

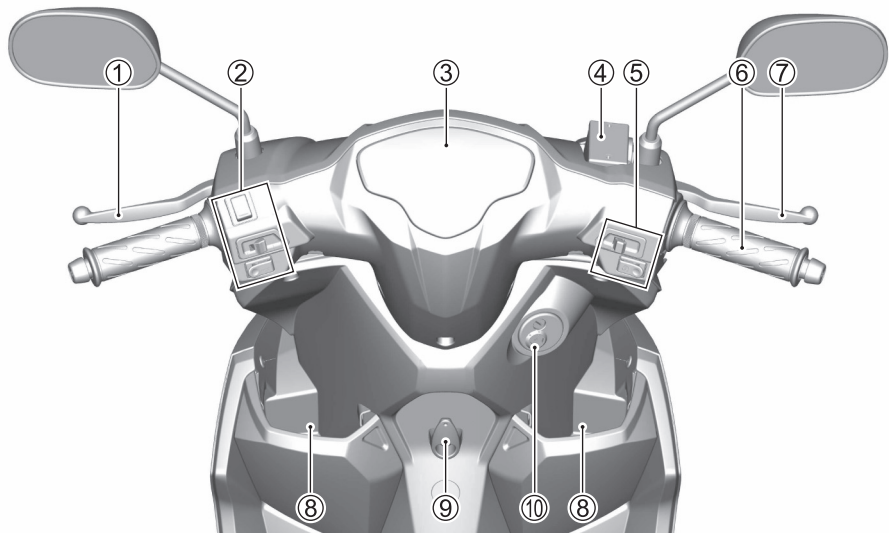

UX110NE/NZ

- ① Rear brake lever
- ② Left handlebar switches
- ③ Instrument panel
- ④ Front brake fluid reservoir
- ⑤ Right handlebar switches
- ⑥ Throttle grip
- ⑦ Front brake lever
- ⑧ Front racks
- ⑨ Front hook
- ⑩ Ignition switch

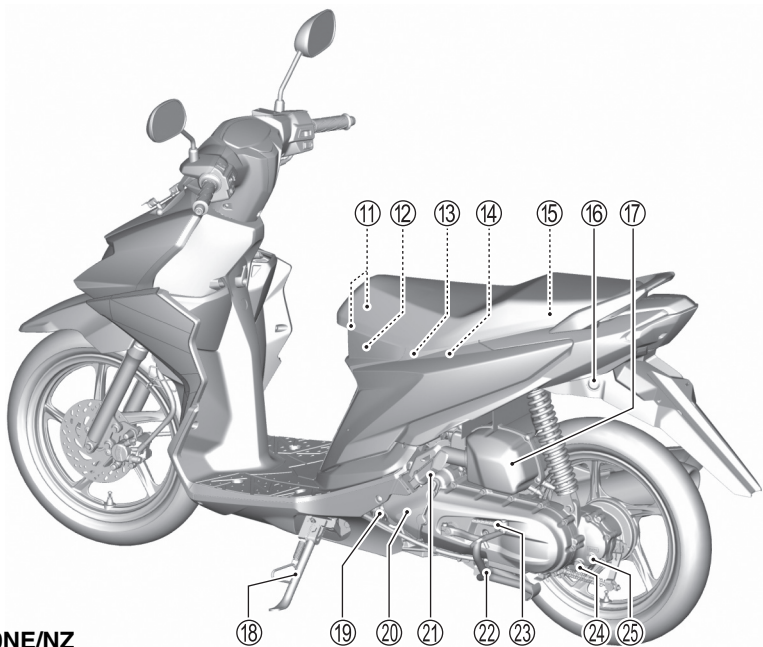

**UX110NE/NZ**

- ⑪ Helmet holders
- ⑫ Tools
- ⑬ Battery and fuses
- ⑭ Trunk
- ⑮ Fuel tank cap
- ⑯ Seat lock
- ⑰ Air cleaner
- ⑱ Side stand
- ⑲ Engine oil filter
- ⑳ Cooling fan filter
- ㉑ Passenger footrest
- ㉒ Center stand
- ㉓ Kick starter lever
- ㉔ Gear oil drain plug
- ㉕ Gear oil filler plug

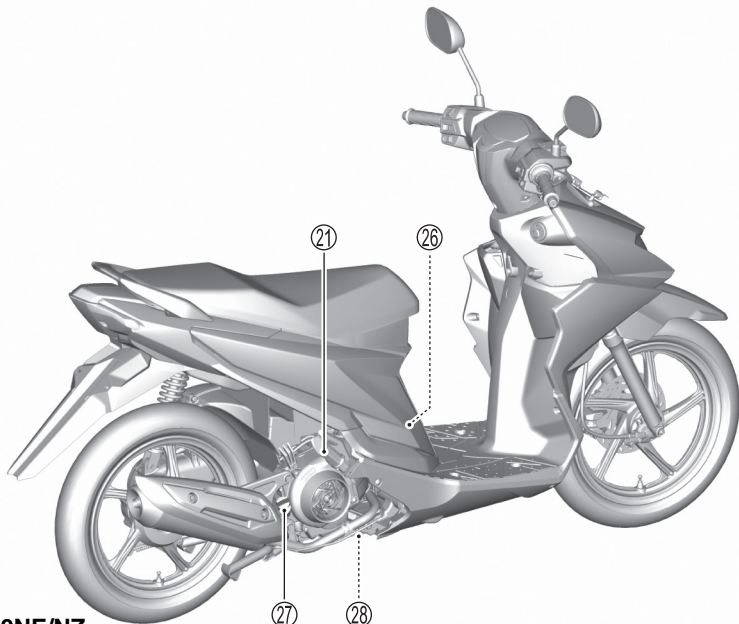

**UX110NE/NZ**

- ②⑥ Spark plug
- ②⑦ Engine oil filler cap
- ②⑧ Engine oil drain plug

## KEY

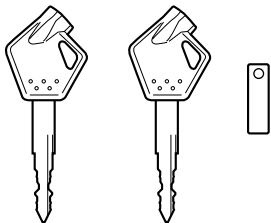

This motorcycle comes equipped with a pair of identical ignition keys. Keep the spare key in a safe place.

The key number is stamped on a plate provided with the keys. This number is used when making replacement keys. Please write your key number in the box provided for your future reference.

Key number:

## IGNITION SWITCH

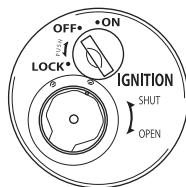

The ignition switch has 3 positions:

### “OFF” Position

All electrical circuits are cut off. The engine will not start. The key can be removed.

### “ON” Position

The ignition circuit is completed and the engine can now be started. The key cannot be removed from the ignition switch in this position.

*NOTE: Start the engine promptly after turning the key to the “ON” position, or the battery will lose power due to consumption by the headlight and taillight.*



## **“LOCK” Position**

To lock the steering, turn the handlebar all the way to the left. Push the key in and turn it to the “LOCK” position and remove the key. All electrical circuits are cut off.

### **WARNING**

Turning the ignition switch to the “LOCK” position while the motorcycle is moving can be hazardous. Moving the motorcycle while the steering is locked can be hazardous. You could lose your balance and fall, or you could drop the motorcycle.

Stop the motorcycle and place it on the center stand or side stand before locking the steering. Never attempt to move the motorcycle when the steering is locked.

### **WARNING**

If the motorcycle falls down due to a slip or collision, unexpected damage to the motorcycle could cause the engine to keep running, which could result in a fire, or could result in injury from moving parts such as the rear wheel.

If the motorcycle falls down, turn the ignition switch off immediately. Ask your authorized Suzuki dealer to inspect the motorcycle for unseen damage.

## **⚠ WARNING**

**Key holders such as metal made or big and heavy ones may disturb riding.**

**Use the key holder of cloth or leather and small one, and check it for no disturbance of handling.**

### **NOTE:**

- *Move the handlebar to the right and left, to make sure that the steering has been locked securely.*
- *When it cannot be locked easily, turn the key to the "LOCK" position, moving the handlebar slightly to the right.*

To open the ignition key-hole shutter:

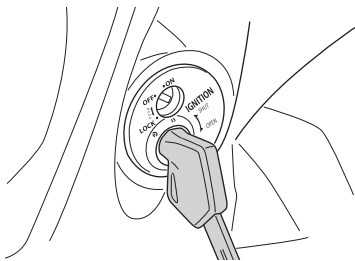

1. Match the ignition key head to the square hole on the ignition switch.
2. Turn the key clockwise.

### **NOTE:**

- *Apply anti-freeze chemicals when atmospheric temperature becomes less than freezing point to avoid ignition key-hole shutter freezing.*
- *Spray anti-corrosion chemicals to the shutter release knob to avoid shutter corrosion trouble.*

## INSTRUMENT PANEL (UX110NER)

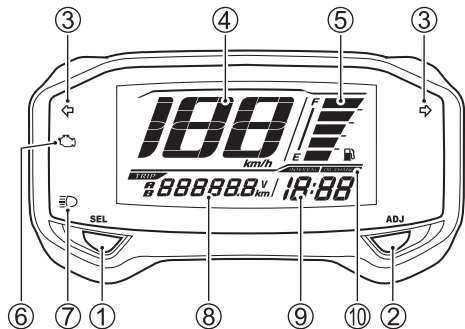

The malfunction indicator light ⑥ and LCD's work as follows to confirm their function when the ignition switch is turned to the "ON" position.

- The malfunction indicator light ⑥ comes on for 3 seconds.
- All LCD segments appear and then show the normal display.

The display indicates the opening pattern shown below:



All LCD display

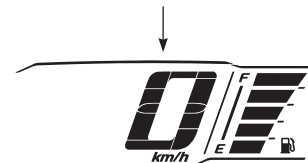

Normal display

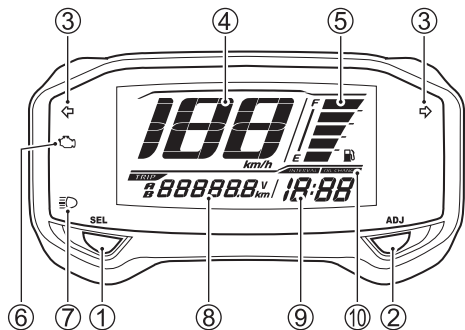

### TURN SIGNAL INDICATOR LIGHT “←→” ③

When the turn signals are being operated either to the right or to the left, the indicator light will blink intermittently.







*NOTE: If a turn signal light is not operating properly due to bulb filament or circuit failure, the indicator light blinks more quickly or is lit continuously to notify the rider of the existence of a problem.*

### SPEEDOMETER ④

The speedometer indicates the road speed in kilometers per hour.

### FUEL LEVEL INDICATOR “🛢️” ⑤

The fuel level indicator indicates the amount of fuel remaining in the fuel tank. The fuel level indicator displays all 5 segments when the fuel tank is full. The mark blinks when the fuel level drops below 1.0 L. The mark and segment blink when the fuel drops below 0.5 L.

Fuel tank	Approximately 0.5 L	Approximately 1.0 L	Full
Fuel gauge	Blink 		
🛢️ mark	Blink 	Blink 	

**NOTE:**

- The fuel level indicator will not indicate correctly when the motorcycle is placed on the side stand. Turn the ignition switch to the “ON” position when the motorcycle is held upright.
- If the fuel mark blinks, fill the fuel tank immediately. Also, the last segment of the fuel level indicator blinks when the fuel tank is almost empty.

**MALFUNCTION INDICATOR LIGHT “”**

⑥

If the fuel injection system fails, the malfunction indicator light ⑥ comes on in following two modes;

- A. The malfunction indicator light ⑥ comes on and remains lit.
- B. The malfunction indicator light ⑥ blinks slowly.

The engine may continue to run in mode A, but the engine may not run in mode B.

**NOTICE**

The malfunction indicator light comes on to indicate a problem with the fuel injection system.

If the malfunction indicator light comes on, have your authorized Suzuki dealer or a qualified mechanic inspect the fuel injection system as soon as possible.

*NOTE: If the indicator light comes on and blinks quickly, the battery voltage is lower. Ask your authorized Suzuki dealer to inspect the motorcycle.*

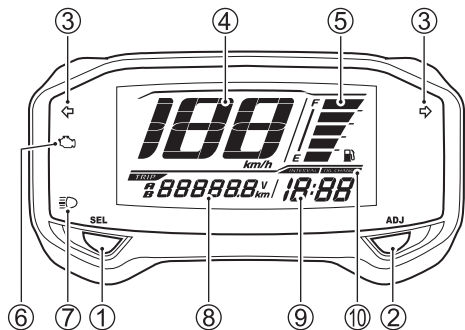

### HIGH BEAM INDICATOR LIGHT “” ⑦

The blue indicator light will be lit when the headlight high beam is turned on.

## ODOMETER/TRIP METER/VOLTMETER

⑧

The display has 4 functions; odometer, two trip meters and voltmeter. When the ignition switch is turned to the “ON” position, the opening pattern shown below is displayed. After the opening pattern is displayed, the display will show the function that was displayed the last time that the ignition switch was turned off.



Change the display, push the SEL button ①.  
The display changes in the order below.

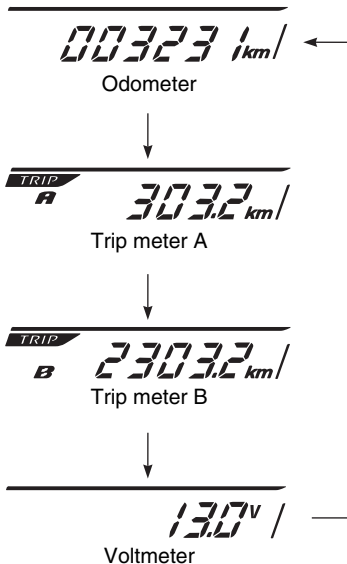

## ODOMETER

The odometer registers the total distance that the motorcycle has been ridden. The odometer ranges from 0 to 999999.

*NOTE: The odometer display locks at 999999 when the total distance exceeds 999999.*

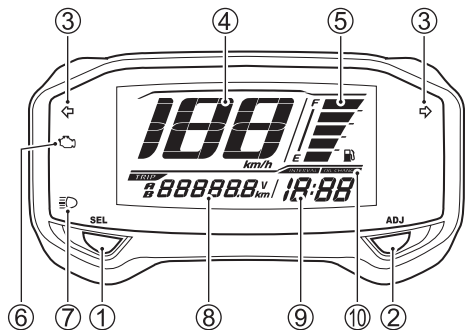

## TRIP METERS

The two trip meters are resettable odometers. They can register two kinds of distances at the same time. For instance, trip meter A can register the trip distance and trip meter B can register the distance between fuel stops.

To reset a meter to zero, press and hold the ADJ button ② for 2 seconds while the display indicates the trip meter A or B, you want to reset.

*NOTE: When the trip meter exceeds 9999.9, the trip meter will return to 0.0 and start counting again.*

## **⚠ WARNING**

**Operating the display while riding can be hazardous. Removing a hand from the handlebars can reduce your ability to control the motorcycle.**

**Always keep both hands on the handlebars during riding.**



## VOLTMETERS

The voltmeter displays the battery voltage within the range of 10.0 to 16.0V.

### NOTE:

- *The displayed value may differ from the value of other instruments.*
- *If a voltage below 12.0V is frequently displayed, have the motorcycle inspected by an authorized Suzuki dealer.*

## CLOCK ⑨



Time is shown when the ignition switch is in the "ON" position. The clock has a 12-hour display. Follow the procedure below to adjust the clock.

1. To adjust the clock, press and hold the SEL button ① and the ADJ button ② simultaneously for 2 seconds until the clock display blinks when adjusting clock.
2. Push the SEL button ① to adjust the hour display.
3. Push the ADJ button ② to adjust the minute display.
4. Press and hold the SEL button ① and the ADJ button ② simultaneously for 2 seconds to return to the clock mode.

### NOTE:

- *When the button is pressed and held, display will increase continuously.*
- *The clock can be adjusted when the ignition switch is in the "ON" position.*
- *This clock is powered by the battery of the motorcycle. If your motorcycle is to be left unused more than two months, remove the battery from the motorcycle.*

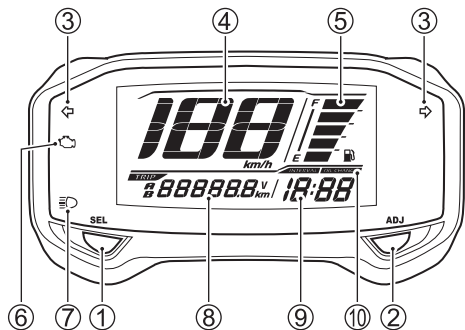

## OIL CHANGE INDICATOR ⑩



The oil change indicator comes on to remind you to change the engine oil. The indicator comes on at initial 1000 km and preset intervals thereafter. The preset interval is adjustable between 500 km and 4000 km in 500 km steps. Reset the indicator after changing the engine oil to turn off the indicator.

To reset the oil change indicator:

1. Turn off the ignition switch.
2. Press and hold the SEL button ① and turn the ignition switch to the "ON" position and hold the SEL button ① for 3 seconds.
3. The oil change counter will reset and the OIL CHANGE indicator blinks 3 times and goes off.

To preset the oil change interval:

1. Set the meter to odometer, then press and hold the ADJ button ② for 2 seconds until the INTERVAL and OIL CHANGE indicators blink.
2. Push the SEL button ① to decrease the interval from 4000 km to 500 km in 500 km steps. Push the ADJ button ② to increase the interval from 500 km to 4000 km in 500 km steps.
3. Press and hold the SEL button ① and the ADJ button ② for 2 seconds to exit the preset.

**NOTE:**

- *The preset interval can be adjusted after odometer reaches 1000 km.*
- *Reset the indicator after initial engine oil replacement.*
- *Reset the indicator after oil replacement even if the indicator is not displayed.*
- *Preset interval change does not reset the indicator.*
- *The preset the interval is factory adjusted to 4000 km.*

## INSTRUMENT PANEL (UX110NE/NZ)

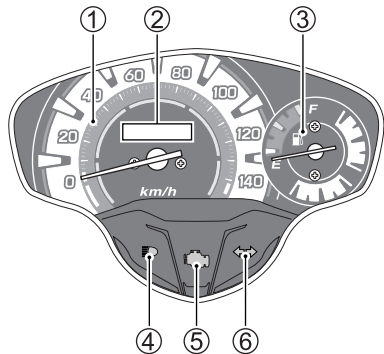

The malfunction indicator light ⑤ comes on for 3 seconds when the ignition switch is turned to the “ON” position.

### **SPEEDOMETER ①**

The speedometer indicates the road speed in kilometers per hour.

### **ODOMETER ②**

The odometer registers the total distance that the motorcycle has been ridden. The odometer ranges from 0 to 99999.9.

*NOTE: The odometer display returns at 00000.0 when the total distance exceeds 99999.9.*

### **FUEL METER “” ③**

The “E” mark indicates the fuel tank is empty or nearly so. The “F” mark indicates the fuel tank is full.

*NOTE: The fuel meter will not indicate correctly when the motorcycle is placed on the side stand. Turn the ignition switch to the “ON” position when the motorcycle is held upright.*

### **HIGH BEAM INDICATOR LIGHT “” ④**

The blue indicator light will be lit when the headlight high beam is turned on.

### **MALFUNCTION INDICATOR LIGHT “” ⑤**

If the fuel injection system fails, the malfunction indicator light ⑤ comes on in following two modes;

- A. The malfunction indicator light ⑤ comes on and remains lit.
- B. The malfunction indicator light ⑤ blinks slowly.

The engine may continue to run in mode A, but the engine may not run in mode B.

## ***NOTICE***

**The malfunction indicator light comes on to indicate a problem with the fuel injection system.**

**If the malfunction indicator light comes on, have your authorized Suzuki dealer or a qualified mechanic inspect the fuel injection system as soon as possible.**

*NOTE: If the indicator light comes on and blinks quickly, the battery voltage is lower. Ask your authorized Suzuki dealer to inspect the motorcycle.*

### **TURN SIGNAL INDICATOR LIGHT “” ⑥**

When the turn signals are being operated either to the right or to the left, the indicator light will blink intermittently.

*NOTE: If a turn signal light is not operating properly due to bulb filament or circuit failure, the indicator light blinks more quickly or is lit continuously to notify the rider of the existence of a problem.*

## LEFT HANDLEBAR

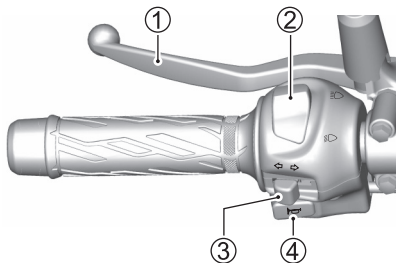

(UX110NER)

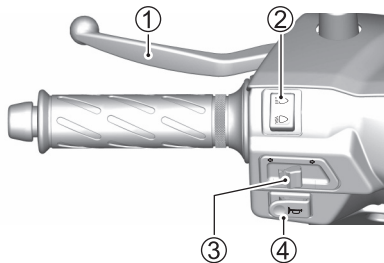

(UX110NE/NZ)

## REAR BRAKE LEVER ①

The rear brake is applied by squeezing the rear brake lever gently towards the grip. The brake light will be lit when the lever is squeezed inward.

## DIMMER SWITCH ②



“” position

The headlight low beam turns on.

“” position

The headlight high beam turns on. The high beam indicator light also comes on.

## **NOTICE**

Holding the dimmer switch between the “” and “” position will light both the high and low headlight beam. This improper operation can damage the motorcycle's headlight.

Use the dimmer switch to select only the “” or “” position.

## ***NOTICE***

**Do not put objects in front of the headlight or taillight when they are on, and do not cover with clothes when the motorcycle is stopped.**



**This may cause melting of the lens or damage to the object by the heat from the lens.**

## ***NOTICE***

**Sticking tape or placing objects in front of the headlight can obstruct headlight heat radiation. This can result in headlight damage.**

**Do not stick tape on the headlight or place objects in front of the headlight.**

## **TURN SIGNAL LIGHT SWITCH “ ” ③**

Moving the switch to the “” position will flash the left turn signals. Moving the switch to the “” position will flash the right turn signals. The indicator light will also flash intermittently. To cancel turn signal operation, push the switch in.

## ****WARNING****

**Failure to use the turn signals, and failure to turn off the turn signals can be hazardous. Other drivers may misjudge your course and this may result in an accident.**

**Always use the turn signals when you intend to change lanes or make a turn. Be sure to turn off the turn signals after completing the turn or lane change.**

## **HORN SWITCH “” ④**

Press the switch to sound the horn.

## RIGHT HANDLEBAR

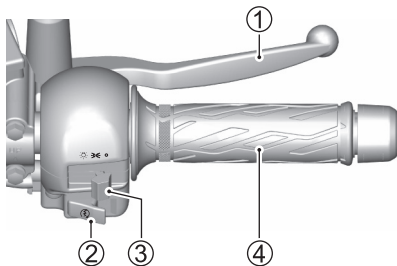

(UX110NER)

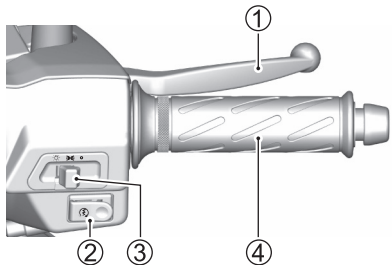

(UX110NE/NZ)

## FRONT BRAKE LEVER ①

The front brake is applied by squeezing the brake lever gently toward the throttle grip. This motorcycle is equipped with a disk brake system and excessive pressure is not required to slow the machine down properly. The brake light will be lit when the lever is squeezed inward.

## ELECTRIC STARTER SWITCH “” ②

Push in the electric starter switch to operate the starter motor.

*NOTE: If the brake lever is not squeezed, the starter motor will not operate.*



## **NOTICE**

Engaging the starter motor for more than five seconds at a time can damage the starter motor and wiring harness from overheating.

Do not engage the starter motor for more than five seconds at a time. If the engine does not start after several attempts, check the fuel supply and ignition system and throttle stop screw. Refer to the **TROUBLESHOOTING** section in this manual.

### **Suzuki Easy Start System**

The Suzuki Easy Start System permits engine starting by simple one-push action on the electric starter switch. When the brake lever is squeezed, the engine can be started.

*NOTE: When the electric starter switch is pushed, the starter motor will continue turning for a few seconds even when you release your hand from the switch. After a few seconds, or when the engine is started, the starter motor will stop automatically.*

### **LIGHT SWITCH ③ (Cambodia)**

 **position**

Headlight and taillight come on when the engine is running.

 **position**

Position light comes on when the engine is running.

 **position**

All lights go off.

### **THROTTLE GRIP ④**

Engine speed is controlled by the position of the throttle grip. Twist it towards you to increase engine speed. Turn it away from you to decrease engine speed.

## FUEL TANK CAP

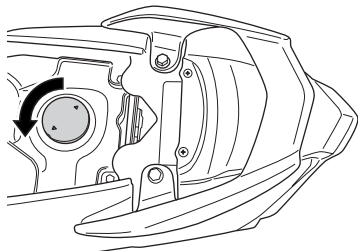

The fuel tank cap is located under the seat. To open the fuel tank cap, turn it counter-clockwise. To close the fuel tank cap, align the cap guides with the slots of the filler neck and turn it clockwise.

Use fresh gasoline when filling up the fuel tank. Do not use bad gasoline which is contaminated with dirt, dust, water or other liquid. Be careful that dirt, dust or water do not enter the fuel tank when refueling.

Fuel tank capacity: 3.6 L

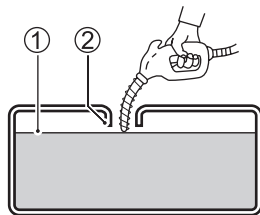

- ① Fuel level
- ② Filler neck

### **WARNING**

If you overfill the fuel tank, fuel may overflow when it expands due to engine heat or heating by the sun. Fuel that overflows can catch fire.

**Stop adding fuel when the fuel level reaches the bottom of the filler neck.**

## **⚠ WARNING**

Failure to follow safety precautions when refueling could result in a fire or cause you to breathe toxic fumes.

Refuel in a well ventilated area. Make sure the engine is off and avoid spilling fuel on a hot engine. Do not smoke, and make sure there are no open flames or sparks in the area. Avoid breathing gasoline vapors. Keep children and pets away when you refuel the motorcycle.

## **KICK STARTER LEVER**

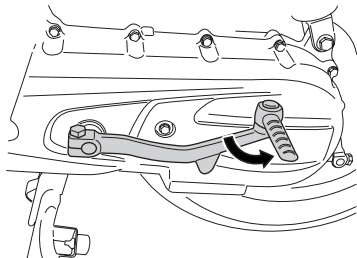

This motorcycle is equipped with a kick starter lever located on the left side of the engine. To start the engine, place the motorcycle on the center stand and depress the kick starter lever forcefully.

## **⚠ WARNING**

**An improperly retracted kick starter lever can interfere with rider control.**

**Be sure the kick starter lever is returned to its home position after starting the engine.**

## **SEAT LOCK AND HELMET HOLDERS**

### **SEAT LOCK**

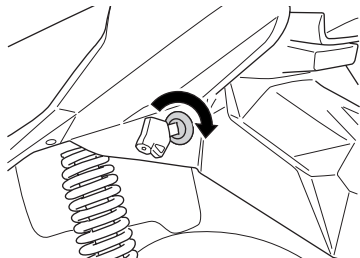

To unlock the seat lock, insert the ignition key into the lock and turn it clockwise. To lock the seat, push down firmly until the seat latch snaps into the locked position.

## HELMET HOLDERS

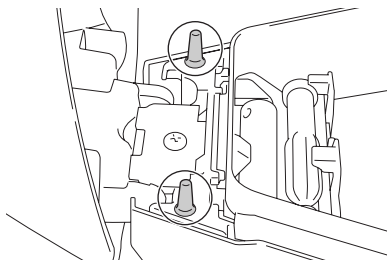

There are helmet holders under the seat. To use it, open the seat, hook your helmet fastener ring to the holder and refit the seat.

### **⚠ WARNING**

**Riding with a helmet fastened to the helmet holder can interfere with rider control.**

**Never carry a helmet fastened to a helmet holder. Fix the helmet securely atop the seat if you must carry it.**

## FRONT HOOK

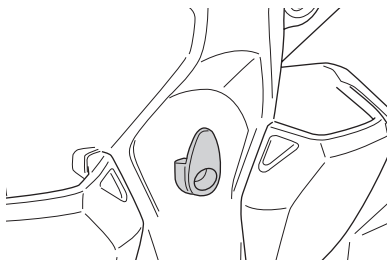

The motorcycle is equipped with the front hook.

The hook load capacity is 1.5 kg.

## FRONT RACKS

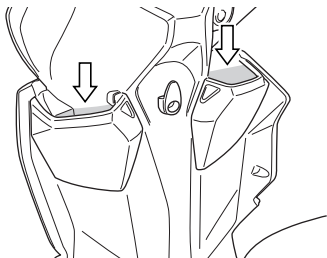

The motorcycle are equipped with the front racks.

The racks total load capacity is 1 kg.

## TRUNK

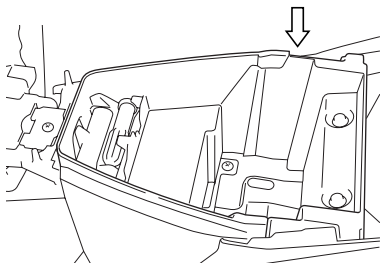

The trunk load capacity is 3 kg. Do not allow water to get inside the trunk.

### **⚠ WARNING**

**Overloading the motorcycle will decrease riding stability and can lead to loss of control.**

**Never exceed the load capacity.**

**NOTE:**

- *Do not keep low heat-resistant items in the trunk since the trunk may get hot.*
- *Do not keep valuable items in the trunk when leaving the motorcycle unattended.*
- *Push down the rear end of the seat if the seat does not unlock with key operation.*

**STANDS**

This motorcycle is equipped with a center stand and side stand.

**CENTER STAND**

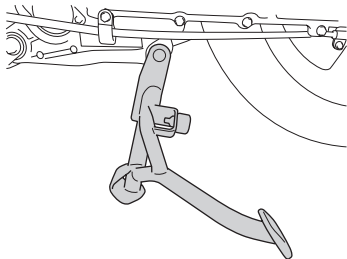

To place the motorcycle on the center stand, place your foot on the stand extension and then rock the motorcycle to the rear and upward with the passenger hand rail with your right hand, while steadying the handlebars with your left hand.

## SIDE STAND

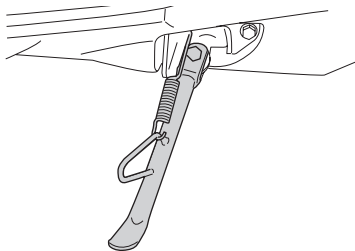

The motorcycle has a side stand. To place the motorcycle on the side stand, place your right foot on the end of the side stand and push down firmly until the stand pivots fully through its arc and comes to rest against its stop.

## **⚠ WARNING**

Riding with the side stand incompletely retracted can result in an accident when you turn left.

Always retract the side stand completely before starting off.

## ***NOTICE***

Park the motorcycle on firm, level ground to help prevent it from falling over.

If you must park on an incline, aim the front of the motorcycle uphill and place the motorcycle on the center stand, or the motorcycle on the side stand may roll off.



# FUEL AND ENGINE OIL RECOMMENDATION

---

FUEL .....	3-2
OXYGENATED FUEL RECOMMENDATION .....	3-3
ENGINE OIL AND GEAR OIL .....	3-4

## FUEL AND ENGINE OIL RECOMMENDATION

### FUEL

Use unleaded gasoline with an octane rating of 91 or higher (Research method).

Unleaded gasoline can extend spark plug life and exhaust components life.

#### NOTE:

- *If the engine develops some trouble like lack of acceleration or insufficient power, the cause may be due to the fuel the motorcycle uses. In such case, try changing to a different gas station. If the situation is not improved by changing, consult your Suzuki dealer.*
- *If pinking or knocking is experienced, substitute higher octane grade gasoline or another brand, because there are differences between brands.*

### **NOTICE**

Spilled gasoline containing alcohol can damage the painted surfaces of your motorcycle.

Be careful not to spill any fuel when filling the fuel tank. Wipe spilled gasoline up immediately.

### **NOTICE**

Do not use leaded gasoline.

Use of leaded gasoline causes the catalytic converter to malfunction.

## OXYGENATED FUEL RECOMMENDATION

Oxygenated fuels which meet the minimum octane requirement and the requirements described below may be used in your motorcycle without jeopardizing the New Vehicle Limited Warranty.

*NOTE: Oxygenated fuels are fuels which contain oxygen carrying additives such as alcohol.*

### Gasoline/Ethanol Blends

Blends of unleaded gasoline and ethanol (grain alcohol), also known as "GASOHOL", are commercially available in some areas. Blends of this type may be used in your motorcycle if they are no more than 10% ethanol. Make sure this gasoline-ethanol blend has octane ratings no lower than those recommended for gasoline.

Use the recommended gasoline.



### NOTE:

- *To help minimize air pollution, Suzuki recommends that you use oxygenated fuels.*
- *Be sure that any oxygenated fuel you use has recommended octane ratings.*
- *If you are not satisfied with the drivability of your motorcycle when you are using an oxygenated fuel, or if engine pinging is experienced, substitute another brand as there are differences between brands.*

## ENGINE OIL AND GEAR OIL

Use Suzuki genuine engine oil or equivalent. If Suzuki genuine engine oil is not available, select a proper engine oil according to the following guideline.

Oil quality is a major contributor to your engine's performance and life. Always select good quality engine oil. Use oil with an API (American Petroleum Institute) classification of SG, SH, SJ, SL, SM or SN with a JASO classification of MB.

Suzuki Genuine Oil



SAE	API	JASO
10W-40	SG, SH, SJ, SL, SM or SN	MB

API: American Petroleum Institute

JASO: Japanese Automobile Standards Organization

## SAE Engine Oil Viscosity

Suzuki recommends the use of SAE 10W-40 engine oil. If SAE 10W-40 engine oil is not available, select an alternative according to the following chart.

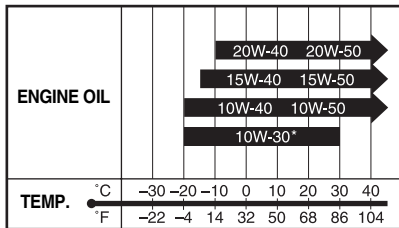

\* USE ONLY SG, SH, SJ or SL.

## JASO T903

The JASO T903 standard is an index to select engine oils for 4-stroke motorcycle and ATV engines. Motorcycle and ATV engines lubricate clutch and transmission gears with engine oil. JASO T903 specifies performance requirements for motorcycle and ATV clutches and transmissions.

There are two classes, MA (MA1, MA2) and MB. For example, the oil container shows the classification as follows.

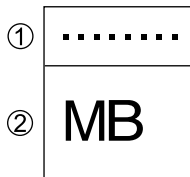

- ① Code number of oil sales company
- ② Oil classification

## Energy Conserving

Suzuki does not recommend the use of “ENERGY CONSERVING” or “RESOURCE CONSERVING” oils. Some engine oils which have an API classification of SH, SJ, SL, SM or SN have an “ENERGY CONSERVING” or “RESOURCE CONSERVING” indication in the API classification donut mark. These oils can affect engine life and clutch performance.

API SG, SH, SJ, SL, SM or SN



Recommended

API SH, SJ, SL or SM

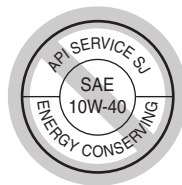

API SN



Not recommended

# BREAK-IN (RUNNING-IN) AND INSPECTION BEFORE RIDING

---

BREAK-IN (RUNNING-IN) .....	4-2
MAXIMUM THROTTLE OPERATION RECOMMENDATION .....	4-2
VARY THE ENGINE SPEED .....	4-2
BREAKING IN THE NEW TIRES .....	4-3
AVOID CONSTANT LOW SPEED .....	4-3
OBSERVE YOUR FIRST AND MOST CRITICAL SERVICE .....	4-4
INSPECTION BEFORE RIDING .....	4-4

## BREAK-IN (RUNNING-IN) AND INSPECTION BEFORE RIDING

### BREAK-IN (RUNNING-IN)

The foreword explains how important proper break-in is to achieve maximum life and performance from your new Suzuki. The following guidelines explain proper break-in procedures.

### MAXIMUM THROTTLE OPERATION RECOMMENDATION

This table shows the maximum recommended throttle operation during the break-in period.

Initial	800 km	Less than 1/2 throttle
Up to	1600 km	Less than 3/4 throttle

### VARY THE ENGINE SPEED

The engine speed should be varied and not held at a constant speed. This allows the parts to be “loaded” with pressure, and then unloaded, allowing the parts to cool. This aids the mating process of the parts. It is essential that some stress be placed on the engine components during break-in to ensure this mating process. Do not, though, apply excessive load on the engine.



## **BREAKING IN THE NEW TIRES**

New tires need proper break-in to assure maximum performance, just as the engine does. Wear in the tread surface by gradually increasing your cornering lean angles over the first 160 km before attempting maximum performance. Avoid hard acceleration, hard cornering, and hard braking for the first 160 km.

### **WARNING**

**Failure to perform break-in of the tires could cause tire slip and loss of control.**

**Use extra care when riding on new tires. Perform proper break-in of the tires as described in this section and avoid hard acceleration, hard cornering, and hard braking for the first 160 km.**

## **AVOID CONSTANT LOW SPEED**

Operating the engine at constant low speed (light load) can cause parts to glaze and not seat in. Allow the engine to accelerate freely through the gears, without exceeding the recommended maximum limits. Do not, however, use full throttle for the first 1600 km.

## OBSERVE YOUR FIRST AND MOST CRITICAL SERVICE

The initial service (1000 km maintenance) is the most important service your motorcycle will receive. During break-in operation, all of the engine components will have mated together and seated. Maintenance required as part of the initial service includes correction of all adjustments, tightening of all fasteners and replacement of dirty oil. Timely performance of this service will help make sure you get the best service life and performance from the engine.

*NOTE: The 1000 km service should be performed as outlined in the INSPECTION AND MAINTENANCE section of this Owner's Manual. Pay particular attention to the CAUTION and WARNING messages in that section.*

## INSPECTION BEFORE RIDING

### **WARNING**

**Failure to inspect your motorcycle before riding and to properly maintain your motorcycle increases the chances of an accident or equipment damage.**

**Always inspect your motorcycle each time you use it to make sure it is in safe operating condition. Refer to the INSPECTION AND MAINTENANCE section in this owner's manual.**

## **WARNING**

If you operate this motorcycle with improper tires or improper or uneven tire pressure, you may lose control of the motorcycle. This will increase your risk of an accident.







Always use tires of the size and type specified in this owner's manual. Always maintain proper tire pressure as described in the **INSPECTION AND MAINTENANCE** section.

Before riding the motorcycle, be sure to check the following items. Never underestimate the importance of these checks. Perform all of them before riding the machine.

## **WARNING**

Checking maintenance items when the engine is running can be hazardous. You could be severely injured if your hands or clothing get caught in moving engine parts.

Shut the engine off when performing maintenance checks, except when checking the lights and throttle.

WHAT TO CHECK	CHECK FOR:
Steering	<ul style="list-style-type: none"> <li>• Smoothness</li> <li>• No restriction of movement</li> <li>• No play or looseness</li> </ul>
Brakes (  6-36)	<ul style="list-style-type: none"> <li>• Proper lever operation</li> <li>• Fluid level in the reservoir to be above "LOWER" line</li> <li>• No fluid leakage</li> <li>• Brake pads/shoes not worn down to the limit line</li> <li>• Correct lever play</li> <li>• No "sponginess"</li> <li>• No dragging</li> </ul>
Tires (  6-44)	<ul style="list-style-type: none"> <li>• Proper pressure</li> <li>• Adequate tread depth</li> <li>• No cracks or cuts</li> </ul>
Fuel (  2-18)	Enough fuel for the planned distance of operation
Lighting (  2-17, 2-26, 2-28)	Operation of all lights and indicators
Horn (  2-29)	Correct function
Engine oil (  6-28)	Correct level

Throttle (  6-23)	<ul style="list-style-type: none"> <li>• Correct play in the throttle cable</li> <li>• Smooth operation and positive return of the throttle grip to the closed position</li> </ul>
---	--

# RIDING TIPS

---

STARTING THE ENGINE .....	5-2
STARTING OFF .....	5-5
STOPPING AND PARKING .....	5-6

## RIDING TIPS

### STARTING THE ENGINE

Sit on the motorcycle and retract the side stand, or place the motorcycle on the center stand. Insert the ignition key into the ignition switch and turn it to the "ON" position.

### **WARNING**

**Starting the engine improperly can be hazardous. Starting the engine with the center stand released can move motorcycle forward as soon as engine starts.**

**Place the motorcycle on the center stand before starting the engine and do not release the center stand until engine revs at idling speed.**

### **NOTICE**

**Racing causes ill effect to the engine such as wasting fuel, engine trouble or breakage.**

**Avoid unnecessary racing.**

*NOTE: If the electric starter switch or kick lever is operated with the throttle grip turned about 2/3 or more, the fuel injection and ignition systems are disabled to prevent starting.*

## **Suzuki Easy Start System**

The Suzuki Easy Start System permits engine starting by simple one-push action on the electric starter switch. When the brake lever is squeezed, the engine can be started.

*NOTE: When the electric starter switch is pushed, the starter motor will continue turning for a few seconds even when you release your hand from the switch. After a few seconds, or when the engine is started, the starter motor will stop automatically.*

## **When the Engine is Cold or Warm:**

1. Check that the throttle grip turns from the fully closed position to the fully opened position smoothly, and returns to the fully closed position smoothly when the grip is released.
2. Squeeze the front or rear brake lever.
3. Close the throttle completely and push the electric starter switch or depress the kick starter lever.

## **When a Engine is Hard to Start:**

1. Check that the throttle grip turns from the fully closed position to the fully opened position smoothly, and returns to the fully closed position smoothly when the grip is released.
2. Squeeze the front or rear brake lever.
3. Open the throttle grip 1/8 to 1/4, push the electric starter switch or depress the kick starter lever.

## **WARNING**

Exhaust gas contains carbon monoxide, a dangerous gas that is difficult to detect because it is colorless and odorless. Breathing carbon monoxide can cause death or severe injury.

Never start the engine or let it run indoors or where there is little or no ventilation.

## ***NOTICE***

Leaving the engine running for an extended period or keeping the throttle opened, without traveling, in order to charge the battery, etc., may cause the engine to overheat. Overheating may damage engine parts or motorcycle parts, and cause the exhaust pipe to change color.

Stop the engine if you do not intend to begin riding promptly.



## STARTING OFF

### **WARNING**

Riding at excessive speeds increases your chances of losing control of the motorcycle, which can result in an accident.

Always ride at a speed that is proper for the terrain, visibility and operating conditions, and your skills and experience.

### **WARNING**

If you remove even one hand or foot from the motorcycle, you can reduce your ability to control the motorcycle. This could cause you to lose your balance and fall off the motorcycle. If you remove a foot from a footrest, your foot or leg may come in contact with the rear wheel. This could injure you or cause an accident.

Always keep both hands on the handlebars and both feet on the footrests of your motorcycle during operation.

Close the throttle and apply the brake when taking the motorcycle off the center stand. Release the front and rear brakes. Open the throttle grip toward you and the motorcycle will start moving forward. Never accelerate while braking.

## **WARNING**

**Sudden side winds, which can occur when being passed by larger vehicles, at tunnel exits or in hilly areas, can cause you to lose control of the motorcycle.**

**Reduce your speed and be alert to the possibility of sudden side winds.**

## **STOPPING AND PARKING**

1. Twist the throttle grip away from yourself to close the throttle completely.
2. Apply the front and rear brakes evenly and at the same time.

## **WARNING**

**Inexperienced riders tend to underutilize the front brake. This can cause excessive stopping distance and lead to a collision. Using only the front or rear brake can cause skidding and loss of control.**

**Apply both brake levers evenly and at the same time.**

## **WARNING**

**Hard braking while turning may cause wheel skid and loss of control.**

**Brake before you begin to turn.**

## **WARNING**

Hard braking on wet, loose, rough, or other slippery surfaces can cause wheel skid and loss of control.

Brake lightly and with care on slippery or irregular surfaces.

## **WARNING**

Following another vehicle too closely can lead to a collision. As vehicle speeds increase, stopping distance increases progressively.

Always maintain a safe stopping distance between you and the vehicle in front of you.

## **NOTICE**

Holding the motorcycle stopped with throttle operation on inclines can damage the motorcycle's clutch.

Use the brakes when stopping the motorcycle on inclines.

3. Park the motorcycle on a firm, flat surface where it will not fall over.

*NOTE: If the motorcycle is to be parked on the side stand on a slight slope, the front end of the motorcycle should face "up" the incline to avoid rolling forward off the side stand.*

4. Apply the side stand or center stand.
5. Turn the ignition switch to the “OFF” position to stop the engine.
6. Turn the ignition switch to the “LOCK” position to lock the steering.
7. Remove the ignition key from the switch.

*NOTE: If an optional anti-theft lock such as a U-shape lock, brake disk lock or chain is used to avoid theft, be sure to remove the anti-theft lock before moving the motorcycle.*

**▲ CAUTION**

**A hot muffler can cause severe burns. The muffler will be hot enough to cause burns for some time after stopping the engine.**

**Park the motorcycle where pedestrians or children are not likely to touch the muffler.**



# INSPECTION AND MAINTENANCE

---

MAINTENANCE SCHEDULE .....	6-2
TOOLS .....	6-6
LUBRICATION POINTS .....	6-6
BATTERY .....	6-9
SPARK PLUG .....	6-13
AIR CLEANER .....	6-18
IDLE SPEED ADJUSTMENT .....	6-22
THROTTLE CABLE PLAY .....	6-23
FUEL HOSE .....	6-24
COOLING FAN FILTER .....	6-26
ENGINE OIL .....	6-28
GEAR OIL .....	6-35
BRAKES .....	6-36
TIRES .....	6-44
LIGHT BULB REPLACEMENT .....	6-49
FUSE .....	6-61
CATALYTIC CONVERTER .....	6-62

## INSPECTION AND MAINTENANCE

### MAINTENANCE SCHEDULE

The chart indicates the intervals between periodic services in kilometers and months. At the end of each interval, be sure to inspect, check, lubricate and service as instructed. If your motorcycle is used under high stress conditions such as continuous full throttle operation, or is operated in a dusty climate, certain services should be performed more often to ensure reliability of the motorcycle as explained in the maintenance section. Your Suzuki dealer can provide you with further guidelines. Steering components, suspension and wheel components are key items and require very special and careful servicing. For maximum safety we suggest that you have these items inspected and serviced by your authorized Suzuki dealer or qualified service mechanic.

### **WARNING**

**Improper maintenance or failure to perform recommended maintenance can lead to an accident.**

**Keep your motorcycle in good condition. Ask your Suzuki dealer or a qualified mechanic to perform the maintenance items marked with an asterisk (\*). You may perform the unmarked maintenance items by referring to the instructions in this section, if you have mechanical experience. If you are not sure how to do any of the jobs, ask your Suzuki dealer to do the maintenance.**

## **WARNING**

Exhaust gas contains carbon monoxide, a dangerous gas that is difficult to detect because it is colorless and odorless. Breathing carbon monoxide can cause death or severe injury.

Never start the engine or let it run indoors or where there is little or no ventilation.

## **NOTICE**

Servicing electric parts with the ignition switch in the "ON" position can damage the electric parts when the electric circuit is shorted.

Turn off the ignition switch before servicing the electric parts to avoid short-circuit damage.

## **NOTICE**

Poorly-made replacement parts can cause your motorcycle to wear more quickly and may shorten its useful life.









When replacing parts on your vehicle, use only genuine Suzuki replacement parts or their equivalent.

*NOTE: The MAINTENANCE CHART specifies the minimum requirements for maintenance. If you use your motorcycle under severe conditions, perform maintenance more often than shown in the chart. If you have any questions regarding maintenance intervals, consult your Suzuki dealer or a qualified mechanic.*





*NOTE: If you use your motorcycle under dusty condition or on water flooded road, shorten the periodic maintenance of cooling fan filter, drive belt and clutch housing maintenance interval.*

## MAINTENANCE CHART

This interval should be judged by number of months or odometer reading, whichever comes first.

Item	Interval	1000	4000	8000	12000	16000	20000
	km Months	1	4	8	12	16	24
Air cleaner element (  6-16)		-	I	I	R	I	R
	Replace every 12,000 km						
*Exhaust pipe bolts and muffler mounting bolts		T	T	T	T	T	T
*Valve clearance		I	I	I	I	I	I
Sparkplug (  6-12)		-	I	R	I	R	I
	Replace every 8,000 km						
Fuel Hose (  6-21)		-	I	I	I	I	I
	Replace every 4 years						
Engine oil (  6-24)		R	R	R	R	R	R
Engine oil filter (  6-27)		R	R	R	R	R	R
Oil strainer (  6-29)		I	I	I	I	I	I
*Gear Oil (  6-31)		I	-	I	-	I	-
Throttle cable play (  6-31)		I	I	I	I	I	I
*Idle Speed (  6-19)		I	I	I	I	I	I
*Drive V-belt		I	I	I	I	I	R
	Replace every 20,000 km or if necessary						



Item	Interval	km	1000	4000	8000	12000	16000	20000
		Months	1	4	8	12	16	24
*Brakes (  6-32)								
		Replace if necessary						
Brake fluid (  6-33)								
		Replace every 2 years						
Brake hose (  6-32)								R
		Replace every 4 years						
Tires (  6-39)								
*Steering								
*Front fork								
*Rear suspension								
*Chassis nuts and bolts		T	T	T	T	T	T	T
Lubrication (  6-7)		Lubricate every 1000km						

**NOTE:** I= Inspect and clean, adjust, replace or lubricate as necessary;  
R= Replace; T= Tighten

## TOOLS

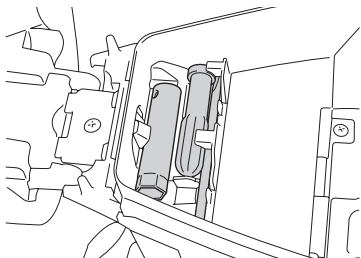

To assist you in the performance of periodic maintenance, a tool kit is supplied and is located under the seat.

## LUBRICATION POINTS

Proper lubrication is important for smooth and long life of each working part of your motorcycle and also for safe riding. It is a good practice to lubricate the motorcycle after a long rough ride and after getting it wet in the rain or after washing it. Major lubrication points are indicated below.

### ***NOTICE***

**Lubricating electrical switches can damage the switches.**

**Do not apply grease or oil to electrical switches.**

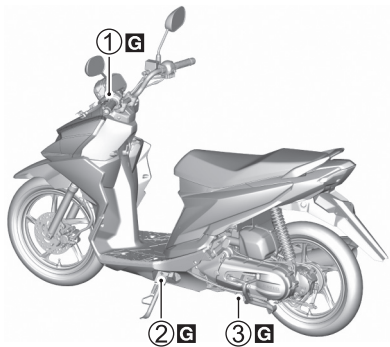

(UX110NER)

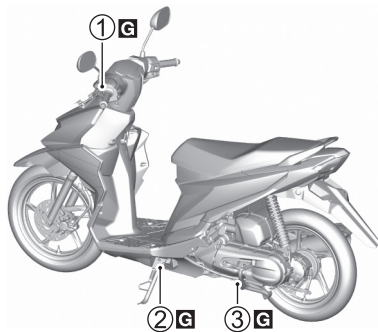

(UX110NE/NZ)

**G**..... Grease

- ①..... Rear brake lever pivot
- ②..... Side stand pivot and spring hook
- ③..... Center stand pivot and spring hook



(UX110NER)



(UX110NE/NZ)

**G**..... Grease

**4**..... Front brake lever pivot

## BATTERY

The battery is a sealed type battery and requires no maintenance. Have your dealer check the battery's state of charge periodically.

### NOTE:

- *For charging a sealed type battery, use a battery charger applicable to a sealed type battery.*
- *If you cannot charge the battery, consult your authorized Suzuki dealer.*

## WARNING

Battery posts, terminals, and related accessories contain lead and lead compounds. Lead is harmful to your health if it gets into your blood stream.

Wash hands after handling any parts containing lead.

## WARNING

Diluted sulfuric acid from the battery can cause blindness or severe burns.

When working near the battery, use proper eye protection and gloves. Flush eyes or body with ample water and get medical care immediately if you suffer injury. Keep batteries out of reach of children.

## WARNING

Batteries produce flammable hydrogen gas which can explode if exposed to flames or sparks.

Keep flames and sparks away from the battery. Never smoke when working near the battery.

## **⚠ WARNING**

Wiping the battery with a dry cloth can cause a static electricity spark, which can start a fire.

Wipe the battery with a damp cloth to avoid static electricity build up.

## **NOTICE**

Exceeding the maximum charging rate for the battery can shorten its life.

Never exceed the maximum charging rate for the battery.

## **BATTERY REMOVAL**

To remove the battery, follow the procedure below:

1. Place the motorcycle on the center stand.
2. Open the seat by referring to the SEAT LOCK AND HELMET HOLDERS section.

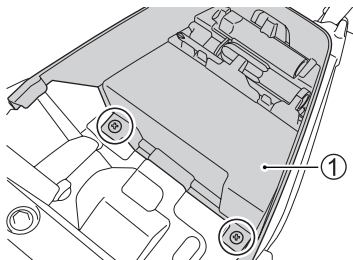

3. Remove the screws.
4. Remove the cover ①.

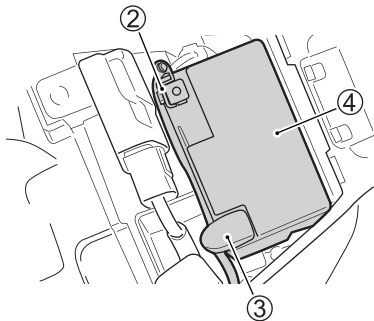

5. Disconnect the negative (-) terminal ②.
6. Remove the cap. Disconnect the positive (+) terminal ③.
7. Remove the battery ④.

To install the battery:

1. Install the battery in the reverse order of removal.
2. Connect the battery terminals securely. Reinstall the cap.

*NOTE: Be sure to connect the battery terminals correctly as shown in the illustration.*

## **NOTICE**

**Reversing the battery lead wires can damage the charging system and the battery.**

**Always attach the red lead to the (+) positive terminal and the black (or black with white tracer) lead to the (-) negative terminal.**

## **WARNING**

Batteries contain toxic substances including sulfuric acid and lead. They could cause injury to humans or could damage the environment.

A used battery must be disposed of or recycled according to local law and must not be discarded with ordinary household waste. Make sure not to tip over the battery when you remove it from the vehicle. Otherwise, sulfuric acid could run out and you might be injured.

### *NOTE:*

- *Select the same type MF battery when replacing the battery.*
- *Recharge the battery once a month if the motorcycle is not used for long term.*

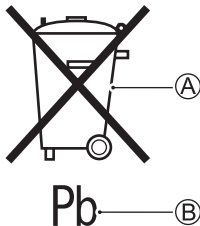

The crossed-out wheeled bin symbol **(A)** located on the battery label indicates that a used battery should be collected separately from ordinary household waste.

The chemical symbol of “Pb” **(B)** indicates the battery contains more than 0.004% lead.



By ensuring the used battery is disposed or recycled correctly, you will help prevent potential negative consequences for the environment and human health, which could otherwise be caused by inappropriate waste handling of the battery. The recycling of materials will help to conserve natural resources. For more detailed information about disposing or recycling of the used battery, consult your Suzuki dealer.

## SPARK PLUG

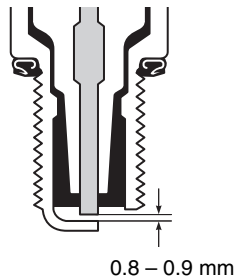

Adjust the spark plug gap to 0.8 – 0.9 mm by using a spark plug gap thickness gauge. The spark plug should be replaced periodically.

Before removing the carbon deposits, observe the color of the porcelain tip of each spark plug. This color tells you whether or not the standard spark plug is suitable for your type of usage. A normally-operating spark plug should be light brown in color. If the spark plug is white or glazed appearing then it has been operating much too hot. This spark plug should be replaced with a colder plug.

## ***NOTICE***

**An improper spark plug may have an incorrect fit or inappropriate heat range for your engine. This may cause severe engine damage which may not be covered under warranty.**

**Use one of the spark plugs listed or their equivalent. Consult your Suzuki dealer if you are not sure which spark plug is correct for your type of usage.**

## **PLUG REPLACEMENT GUIDE**

<b>NGK</b>	<b>DENSO</b>	<b>REMARKS</b>
CPR6EA-9	U20EPR9	If the standard plug is apt to get wet, replace with this plug.
CPR7EA-9	U22EPR9	Standard
CPR8EA-9	U24EPR9	If the standard plug is apt to overheat, replace with this plug.

To remove the spark plug, follow the procedure below:

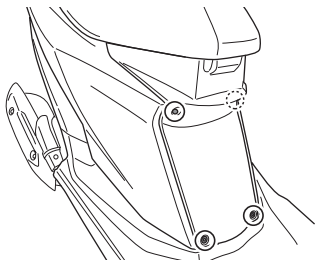

1. Remove the screws and fasteners.

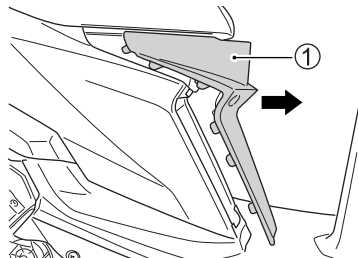

2. Pull the front frame cover ① and slide the front frame cover in a direction with an arrow to remove it.

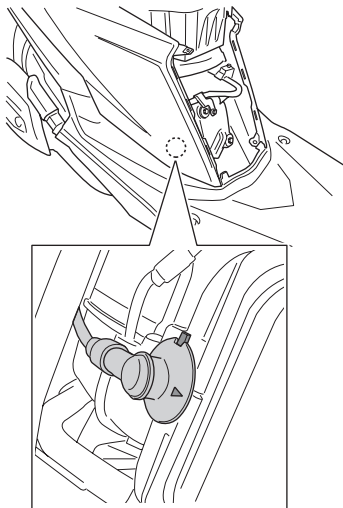

3. Disconnect the spark plug cap.
4. Remove the spark plug with a spark plug wrench.

## INSTALLATION

### ***NOTICE***

Improper installation of the spark plug can damage your motorcycle. An overly-tight or cross-threaded spark plug will damage the aluminum threads of the cylinder head.

Carefully turn the spark plug by hand into the threads. If the spark plug is new, tighten it with a wrench about 1/2 turn past finger tight. If you are reusing the old spark plug, tighten it with a wrench about 1/8 turn past finger tight.

### ***NOTICE***

Dirt can damage the moving engine parts of your motorcycle if it enters an open spark plug hole.

Cover the spark plug hole while the spark plug is out of the hole.

## AIR CLEANER

If the elements have become clogged with dust, intake resistance will increase with a resultant decrease in power output and an increase in fuel consumption. If you use your motorcycle under normal low-stress conditions, you should service the air cleaner at the intervals specified. If you ride in dusty, wet or muddy conditions, you will need to inspect the air cleaner element much more frequently. Use the following procedure to remove the element and inspect it.

### **WARNING**

**Operating the engine without the air cleaner element in place can be hazardous. A flame can spit back from the engine to the air intake box without the air cleaner element to stop it. Severe engine damage can also occur if dirt enters the engine due to running the engine without the air cleaner element.**

**Never run the engine without the air cleaner element in place.**

## ***NOTICE***

**Failure to inspect the air cleaner element frequently if the vehicle is used in dusty, wet, or muddy conditions can damage your motorcycle. The air cleaner element can become clogged under these conditions, and engine damage may result.**

**Always inspect the air cleaner element after riding in severe conditions. Replace the element as necessary. If water gets in the air cleaner case, immediately clean the element and the inside of the case.**

Follow the procedure below to remove the air cleaner element.

1. Place the motorcycle on the center stand.

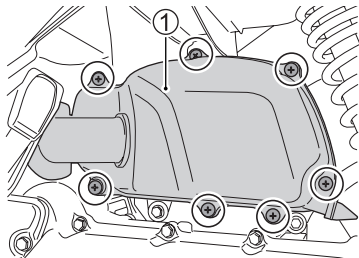

2. Remove the screws and air cleaner cap ①.

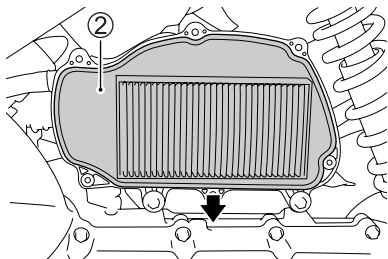

3. Remove the air cleaner element ②.
4. Inspect the air cleaner element condition. Replace the air cleaner element periodically.

### **▲ CAUTION**

Compressed air can damage the air cleaner element.

Do not blow the air cleaner element with compressed air.

*NOTE: If driving under dusty conditions, replace the air cleaner element more frequently. The surest way to accelerate engine wear is to operate the engine without the element or to use a torn element. Make sure that the air cleaner is in good condition at all times. The life of the engine depends largely on this component.*

5. Reinstall the new air cleaner element in reverse order of removal. Be absolutely sure that the element is securely in position and is sealing properly.

### **NOTICE**

A torn air cleaner element will allow dirt to enter the engine and can damage the engine.

Replace the air cleaner element with a new one if it is torn. Carefully examine the air cleaner element for tears during cleaning.



## ***NOTICE***

Failure to position the air cleaner element properly can allow dirt to bypass the air cleaner element. This will cause engine damage.

Be sure to properly install the air cleaner element.

*NOTE: Be careful not to spray water on the air cleaner box when cleaning the motorcycle.*

## **AIR CLEANER DRAIN PLUGS**

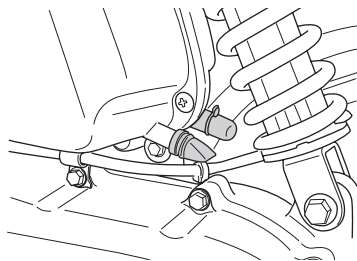

Remove the plugs and drain water and oil at the periodic maintenance interval. The air cleaner drain plugs are located beneath the air cleaner box.

## IDLE SPEED ADJUSTMENT

Follow the procedure below to adjust the throttle stop screw.

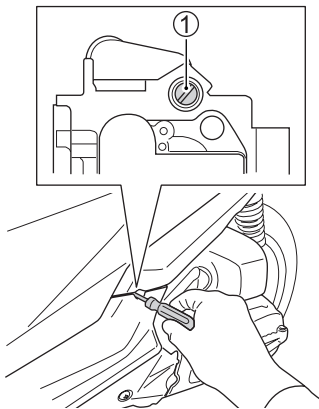

1. Start up the engine and let the engine run until it warms up fully.

2. After engine warms up, turn the throttle stop screw ① in or out so that engine may run at 1400 – 1600 r/min.

*NOTE: If you have a tachometer, you can do this adjustment by referring to the procedures described above. If you do not have one, ask your Suzuki dealer or a qualified mechanic to perform this adjustment.*

## THROTTLE CABLE PLAY

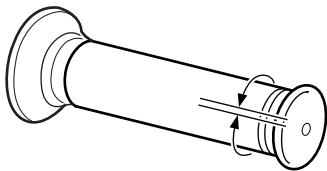
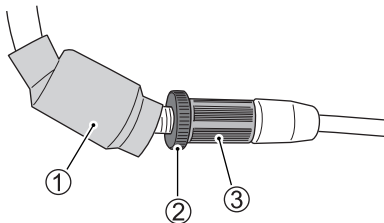

2.0 – 4.0 mm

To adjust the cable play:

1. Remove the boot (1).
2. Loosen the lock nut (2).
3. Turn the adjuster (3) so that the throttle grip has 2.0 – 4.0 mm play.
4. Tighten the lock nut (2).
5. Replace the boot (1).

### **⚠ WARNING**

**Inadequate throttle cable play can cause engine speed to rise suddenly when you turn the handlebar. This can lead to loss of control and an accident.**

**Adjust the throttle cable play so that engine idle speed does not rise due to handlebar movement.**

## THROTTLE CABLE BOOTS

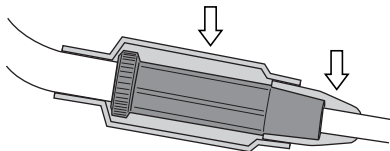

The throttle cable has a boots. Check that the boots are fit securely. Do not apply water directly to the boots when washing. Wipe off dirt from the boots with a wet cloth when the boots are dirty.

## FUEL HOSE

The fuel hose is located under the seat and behind the front frame cover.

1. Open the seat by referring to the SEAT LOCK AND HELMET HOLDERS section.
2. Remove the front frame cover by referring to the SPARK PLUG section.

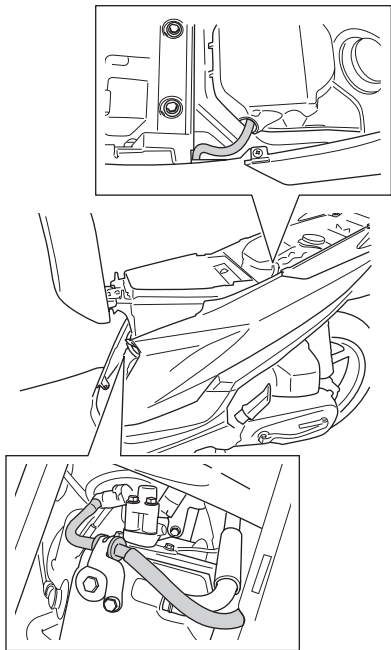

3. Inspect the fuel hose for damage and fuel leakage. If any defects are found, the fuel hose must be replaced.

## COOLING FAN FILTER

The cooling fan filter is located on the left side of crankcase assembly. Clean the cooling fan filter every 4000 km.

Follow the procedure below to remove the cooling fan filter.

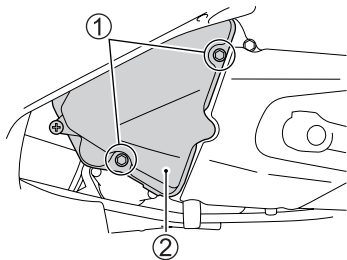

1. Remove the bolts ① and cooling fan filter box assembly ②.

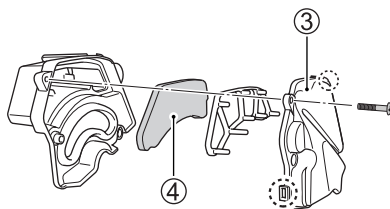

2. Remove the screw.
3. Unhook the hooks and cooling fan filter box cap ③.
4. Remove the cooling fan filter ④.

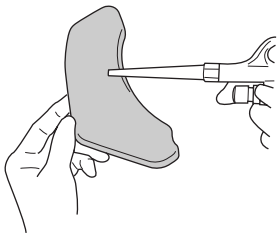

5. Carefully use an air hose to blow the dust from the cooling fan filter.

## COOLING FAN DRAIN PLUG

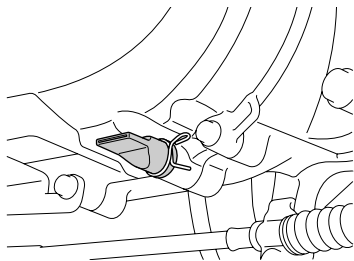

Remove the plug and drain water at the periodic maintenance interval. The cooling fan drain plug is located beneath the clutch cover.

## ENGINE OIL

Long engine life depends much on the selection of a quality oil and the periodic changing of the oil. Daily oil level checks and periodic changes are two of the most important maintenance items to be performed.

### ENGINE OIL LEVEL CHECK

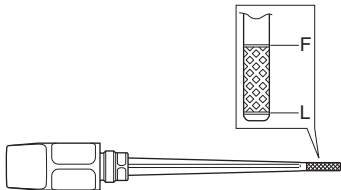

Check the engine oil level with the engine oil dipstick. The dipstick comes out together with the oil filler cap as shown. The level found in the dipstick should be between “L” (Low) and “F” (Full) lines.

The oil level inspection should be performed under the following conditions:

1. Place the motorcycle on the center stand.
2. Start the engine and allow it to idle for about three minutes. If the engine is cold, warm up the engine sufficiently.
3. Stop the engine and wait approximately three minutes.
4. Remove the oil dipstick and clean the dipstick.
5. Insert the oil dipstick through the oil filler hole. The oil filler cap threads should not be run in but touching should be the filler hole upper edge.
6. Pull out the oil dipstick and inspect the oil level.
7. Refit the oil dipstick.



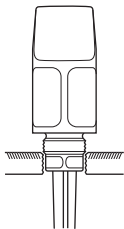

## ***NOTICE***

Operating the motorcycle with too little or too much oil can damage the engine.

Place the motorcycle on level ground. Check the oil level with the engine oil dipstick before each use of the motorcycle. Be sure the engine oil level is always above the “L” (low) line and not higher than the “F” (full) line.

## **ENGINE OIL AND FILTER CHANGE**

Change the engine oil and oil filter at the scheduled time. The oil should be changed when the engine is warm so that the oil will drain thoroughly from the engine. The procedure is as follows:

1. Place the motorcycle on the center stand.

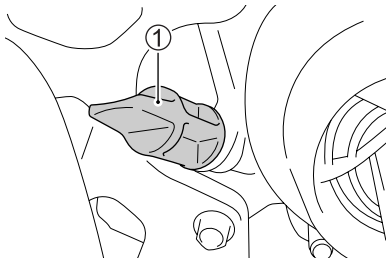

2. Remove the oil filler cap ①.
3. Place a drain pan under the drain plug.

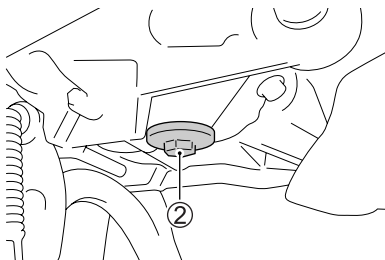

- Using a wrench, remove the drain plug ② and drain out the engine oil.

## **▲ CAUTION**

Hot engine oil and exhaust pipes can burn you.

Wait until the oil drain plug and exhaust pipes are cool enough to touch with bare hands before draining oil.

## **▲ WARNING**

Children and pets may be harmed by swallowing new or used oil. Repeated, prolonged contact with used engine oil may cause skin cancer. Brief contact with oil may irritate skin.

Keep new and used oil and used oil filters away from children and pets. To minimize your exposure to used oil, wear a long-sleeve shirt and moisture-proof gloves (such as dishwashing gloves) when changing oil. If oil contacts your skin, wash thoroughly with soap and water. Launder any clothing or rags if wet with oil. Recycle or properly dispose of used oil and filters.

## NOTICE

Turning the engine while draining the engine oil will cause oil film shortage and adversely affect the engine.

Do not use the electric starter switch during engine oil replacement work.

### NOTE:

- *Recycle or properly dispose of used oil.*
- *Before starting the work, check that there is not any dust, mud, or foreign object inside the oil jug or on the oil filter mounting surface.*

### Oil filter changing

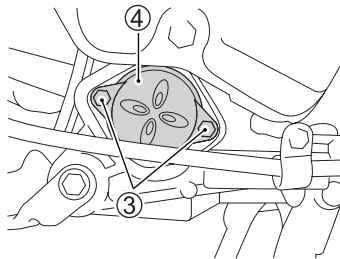

5. Remove the bolts ③ holding the filter cap ④ in place.

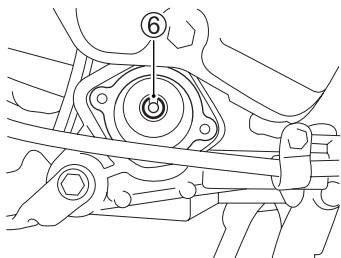
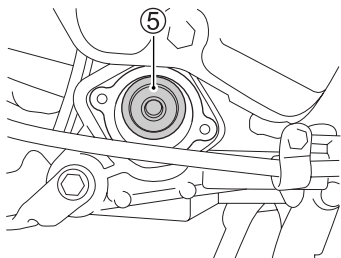

6. Replace the oil filter ⑤ and the “O” ring ⑥ with a new one.

## ***NOTICE***

Failure to use an oil filter with the correct design can damage your motorcycle's engine.

Be sure to use a genuine Suzuki oil filter or an equivalent one designed for your motorcycle.

## ***NOTICE***

Failure to insert the new oil filter correctly can damage the engine. No oil flow will result if the oil filter is inserted backwards.

Insert the open end of the new oil filter into the engine.

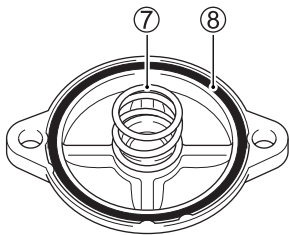

7. Before replacing the oil filter cap, be sure to check that the filter spring (7) and the “O” ring (8) are installed correctly.

*NOTE: Insert a new “O” ring each time the filter element is replaced.*

8. Replace the oil filter cap and tighten the bolts securely but do not overtighten them.

## Oil strainer cleaning

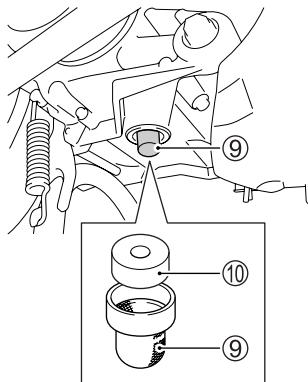

9. Remove the oil strainer (9) and the oil strainer plug (10).

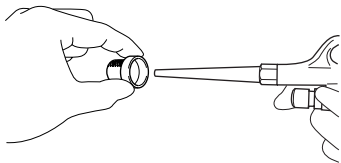

10. Carefully use an air hose to blow the contamination from the oil strainer.

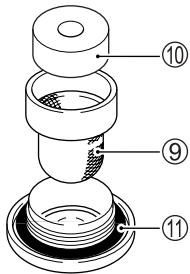

11. Before replacing the drain plug, be sure to check that the oil strainer plug ⑩, the strainer ⑨ and the “O” ring ⑪ are installed correctly.

*NOTE: Insert a new “O” ring each time the engine oil is replaced.*

12. Replace the drain plug and tighten it securely with a torque wrench. Pour fresh oil through the filler hole. Approximately 700 ml will be required.

Drain plug tightening torque:  
35 N·m (3.6 kgf·m, 26.0 lbf·ft)

*NOTE: About 650 ml of oil will be required when changing oil only.*

## **NOTICE**

**Engine damage may occur if you use oil that does not meet Suzuki’s specifications.**

**Be sure to use the oil specified in the FUEL AND ENGINE OIL RECOMMENDATIONS section.**

13. Tighten the oil filler cap.
14. Start the engine and allow it to idle for three minutes.
15. Check the oil level according to Oil Level Check procedure.

*NOTE: Check to see that no oil is leaking from the oil filter cap.*

## GEAR OIL

Change the gear oil at the scheduled time. The procedure is as follows:

1. Place the motorcycle on the center stand.

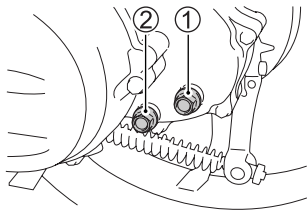

2. Remove the oil filler plug ①.
3. Drain the oil by removing the drain plug ② into a suitable container from the bottom of the final gear case.
4. Reinstall the drain plug ② and tighten it securely after all the oil has been drained out. Pour fresh oil through the filler hole. Approximately 90 ml of oil will be required.
5. Reinstall the oil filler plug ①.

## **WARNING**

**Children and pets may be harmed by swallowing new or used oil. Repeated, prolonged contact with used engine oil may cause skin cancer. Brief contact with oil may irritate skin.**

**Keep new and used oil away from children and pets. To minimize your exposure to used oil, wear a long-sleeve shirt and moisture-proof gloves (such as dishwashing gloves) when changing oil. If oil contacts your skin, wash thoroughly with soap and water. Launder any clothing or rags if wet with oil. Recycle or properly dispose of used oil.**

*NOTE: Recycle or properly dispose of used oil.*

## **BRAKES**

This motorcycle utilizes a disk brake on the front and a drum brake on the rear. Properly operating brake systems is vital to safe riding. Be sure to perform the brake inspection requirements as scheduled. The brakes should be inspected at periodic inspection by your authorized Suzuki dealer.



## BRAKE SYSTEM

### **WARNING**

**Failure to properly inspect and maintain your motorcycle's brake systems can increase your chance of having an accident.**

**Be sure to inspect the brakes before each use according to the INSPECTION BEFORE RIDING section. Always maintain your brakes according to the MAINTENANCE SCHEDULE.**

Inspect your brake system for the following items daily:

- Inspect the front brake system for signs of fluid leakage.
- Inspect the front brake hose for leakage or a cracked appearance.
- Check the wear of the disk brake pads and drum brake shoe.
- The rear brake lever should have the proper stroke and be firm at all times.

## BRAKE HOSE INSPECTION

Inspect the brake hoses and hose joints for cracks, damage or brake fluid leakage. If any defects are found, ask your Suzuki dealer to replace the brake hose with a new one.

## FRONT BRAKE FLUID

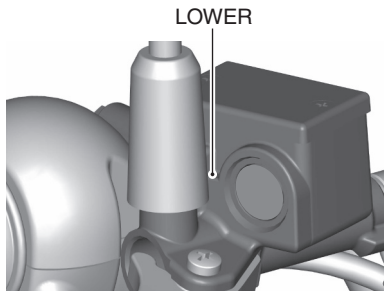

(UX110NER)

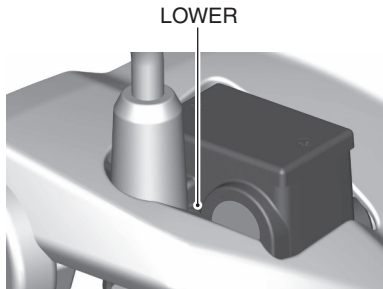

(UX110NE/NZ)

Check the brake fluid level in the front brake fluid reservoir. If the level in reservoir is below the lower mark, inspect pad wear and leaks.

## **WARNING**

Brake fluid will gradually absorb moisture through the brake hoses. Brake fluid with high water content lowers the boiling point and can cause brake system malfunction due to corrosion of brake components. Boiling brake fluid or brake system malfunction could result in an accident.

Replace the brake fluid every two years to maintain braking performance.

## **WARNING**

The use of any fluid except DOT3 or DOT4 brake fluid from a sealed container can damage the brake system and lead to an accident.

Clean filler cap before removing. Use only DOT3 or DOT4 brake fluid from a sealed container. Never use or mix with different types of brake fluid.

## **WARNING**

Brake fluid is harmful or fatal if swallowed, and harmful if it comes in contact with skin or eyes. Solution can be poisonous to animals.

If brake fluid is swallowed, do not induce vomiting. Immediately contact a poison control center or a physician. If brake fluid gets in eyes, flush eyes with water and seek medical attention. Wash thoroughly after handling. Keep out of the reach of children and animals.

## ***NOTICE***

Spilled brake fluid can damage painted surfaces and plastic parts.

Be careful not to spill any fluid when filling the brake fluid reservoir. Wipe spilled fluid up immediately.

## BRAKE PAD

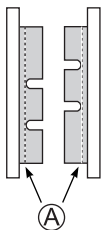
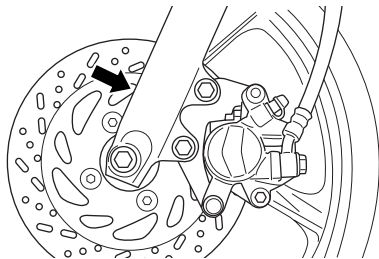

Inspect the front brake pads by noting whether or not the friction pads are worn down to the grooved wear limit line (A). If a pad is worn to the grooved wear limit line, it must be replaced with a new one by your authorized Suzuki dealer or a qualified service mechanic.

### **⚠ WARNING**

**Failure to inspect and maintain the brake pads and replace them when recommended can increase your chance of having an accident.**

**If you need to replace brake pads, have your Suzuki dealer do this work. Inspect and maintain the brake pads as recommended.**

*NOTE: After replacing either the front brake pads, the front brake lever must be pumped several times. This will extend the pads to their proper position.*

## **WARNING**

If you ride this motorcycle after brake system repair or brake pad replacement without pumping the brake lever, you may get poor braking performance which could result in an accident.

After brake system repair or brake pad replacement, pump the front brake lever several times until brake pads are pressed against the brake disks and proper lever stroke and firm feel are restored.

*NOTE: Do not squeeze the brake lever when the pads are not in their positions. It is difficult to push the pistons back and brake fluid leakage may result.*

## **WARNING**

Replacing only one of the two brake pads can result in uneven braking action and can increase your chance of having an accident.

Always replace both pads together.

## REAR BRAKE LEVER PLAY ADJUSTMENT

Initial 1000 km and every 4000 km, check the brakes as follows:

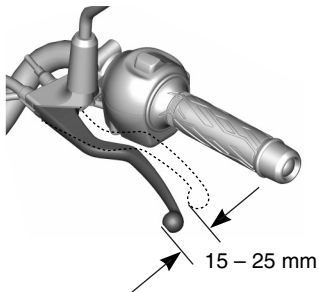

(UX110NER)

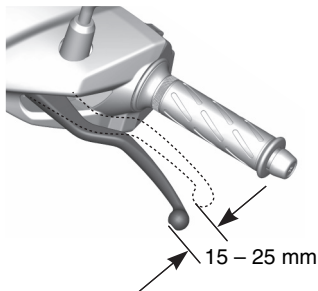

(UX110NE/NZ)

1. Measure the rear brake lever play at the brake lever end. The play should be 15 – 25 mm.

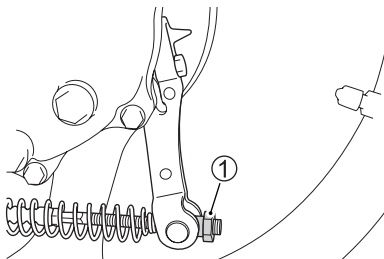

2. If adjustment is necessary, turning the rear brake adjusting nut ① clockwise or counterclockwise will decrease or increase the distance.

## REAR BRAKE LINING WEAR LIMIT

The motorcycle is equipped with the brake lining wear limit indicator on brake panels. To check wear of the brake lining perform the following procedure:

1. Check if the brake system is properly adjusted.

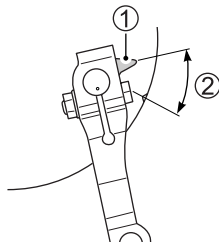

2. While fully applying the brake, check that the indicator ① is within the range ② on the brake panel as shown.
3. If the indicator is beyond the range, the brake shoe assembly should be replaced by your Suzuki dealer to ensure safe operation.

## TIRES

### **WARNING**

The tires on your motorcycle form the crucial link between your motorcycle and the road. Failure to take the precautions below may result in an accident due to tire failure.

- Check tire condition and pressure before each ride, and adjust pressure if necessary.
- Avoid overloading your motorcycle.
- Replace a tire when worn to the specified limit, or if you find damage such as cuts or cracks.
- Always use the size and type of tires specified in this owner's manual.
- Read this section of the owner's manual carefully.

### **WARNING**

Failure to perform break-in of the tires could cause tire slip and loss of control, which could result in an accident.

Use extra care when riding on new tires. Perform proper break-in of the tires referring to the **BREAK-IN** section of this manual and avoid hard acceleration, hard cornering, and hard braking for the first 160 km.

Check the tire inflation pressure and tire tread condition at the periodic inspection. For maximum safety and good tire life, the tire pressures should be inspected more often.



## TIRE PRESSURE AND LOADING

Proper tire pressure and proper tire loading are important factors. Overloading your tires can lead to tire failure and loss of motorcycle control.

Check tire pressure each day before you ride, and adjust tire pressure and be sure the pressure is correct for the motorcycle load according to the table as follows. Tire pressure should only be checked and adjusted before riding, since riding will heat up the tires and lead to higher inflation pressure readings.

## Cold Tire Inflation Pressure

	SOLO RIDING	DUAL RIDING
FRONT	200 kPa 2.00 kgf/cm <sup>2</sup> 29 psi	200 kPa 2.00 kgf/cm <sup>2</sup> 29 psi
REAR	225 kPa 2.25 kgf/cm <sup>2</sup> 33 psi	225 kPa 2.25 kgf/cm <sup>2</sup> 33 psi

Under-inflated tires make smooth cornering difficult, and can result in rapid tire wear. Over-inflated tires cause a smaller amount of tire to be in contact with the road, which can contribute to skidding and loss of control.

*NOTE: When you detect drops in tire pressure, check the tire for nails or other punctures, or a damaged wheel rim. Tubeless tires sometimes lose pressure gradually when punctured.*

## TIRE CONDITION AND TYPE

Proper the condition of your tires and proper tire type affect motorcycle performance. Cuts or cracks in the tires can lead to tire failure and loss of motorcycle control. Worn tires are susceptible to puncture failures and subsequent loss of motorcycle control. Tire wear also affects the tire profile, changing motorcycle handling characteristics.

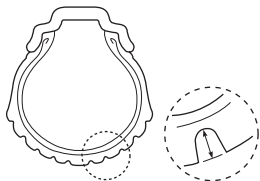

Check the condition of your tires each day before you ride. Replace tires if tires show visual evidence of damage, such as cracks or cuts, or if tread depth is less than 1.6 mm front, 1.6 mm rear.

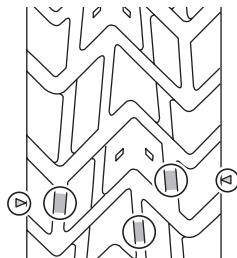

(UX110NER)

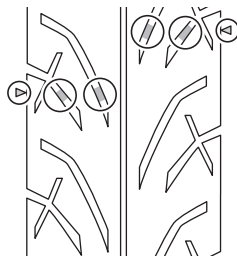

(UX110NE/NZ)

*NOTE: The “Triangle” mark indicates the place where the wear bars are molded into the tire. When the wear bars contact the road, it indicates that the tire wear limit has been reached.*

Whenever you replace a tire, use a tire of the size and type listed below. If you use a different size or type of tire, vehicle handling may be adversely affected, possibly resulting in loss of vehicle control.

	FRONT	REAR
SIZE	80/90-14M/C 40P	90/90-14M/C 46P
TYPE	IRC GP-5 (UX110NER)	IRC GP-5 (UX110NER)
	IRC SS-530F TUBELESS (UX110NE/NZ)	IRC SS-530R TUBELESS (UX110NE/NZ)

## **WARNING**

**An improperly repaired, installed tire can cause loss of control and an accident, or can wear out sooner.**

- **Ask your Suzuki dealer or a qualified mechanic to perform tire repair and replacement, because proper tools and experience are required.**
- **Install tires according to the rotation direction shown by arrows on the sidewall of each tire.**

## **WARNING**

Failure to follow the instructions below for tubeless tires may result in an accident due to tire failure. Tubeless tires require different service procedures than tube tires.

- Tubeless tires require an air-tight seal between the tire bead and wheel rim. Special tire irons and rim protectors or a specialized tire mounting machine must be used for removing and installing tires to prevent tire or rim damage which could result in an air leak.
- Repair punctures in tubeless tires by removing the tire and applying an internal patch.
- Do not use an external repair plug to repair a puncture since the plug may work loose as a result of the cornering forces experienced by a motorcycle tire.

- After repairing a tire, do not exceed 80 km/h for the first 24 hours. This is to avoid excessive heat build-up which could result in a tire repair failure and tire deflation.
- Replace the tire if it is punctured in the sidewall area, or if a puncture in the tread area is larger than 6 mm. These punctures cannot be repaired adequately.

## LIGHT BULB REPLACEMENT

The wattage rating of each bulb is shown on the chart below. When replacing a burned out bulb, always use the exact same wattage rating. Using other than the specified rating can result in overloading the electrical system or premature failure of a bulb.

### ***NOTICE***

**Failure to use a light bulb with the correct wattage rating can overload the electrical system of your motorcycle or cause the bulb to burn out sooner.**

**Use only the light bulbs shown in the chart as replacement bulbs.**

Headlight	12V 32/32W
Front turn signal light	12V 10W × 2
Rear turn signal light	12V 10W × 2
Brake light/Taillight	12V 18/5W
Position light	12V 3.4W

## HEADLIGHT, FRONT TURN SIGNAL LIGHT AND POSITION LIGHT

To replace the headlight bulb, front turn signal light bulb and position light bulb, follow the procedure below:



1. Remove the screws ①.

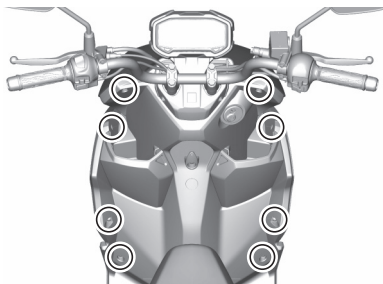

(UX110NER)

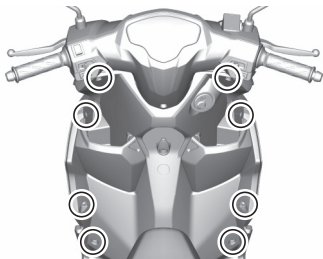

(UX110NE/NZ)

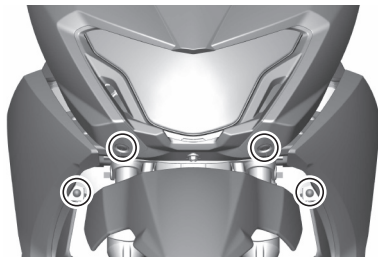

2. Remove the screws and fasteners.



(UX110NER)



(UX110NE/NZ)



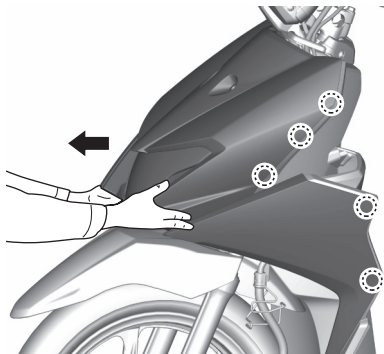

(UX110NER)

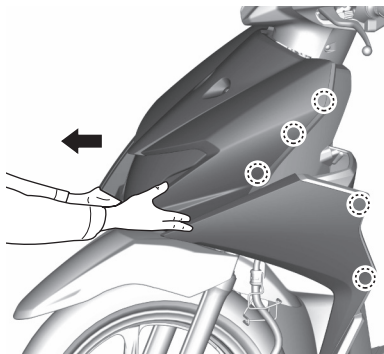

(UX110NE/NZ)

3. Unhook the hooks. Remove the headlight cover with the headlight assembly.

## Headlight

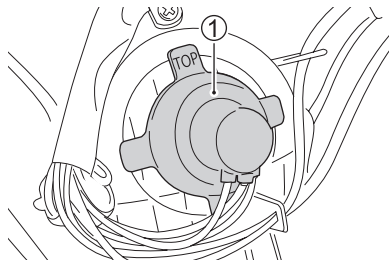

1. Remove the rubber cap ①.

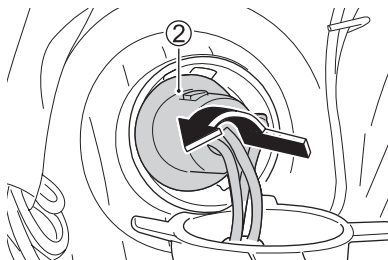

2. Push in on the socket ②, twisting it counterclockwise, and pull it out.

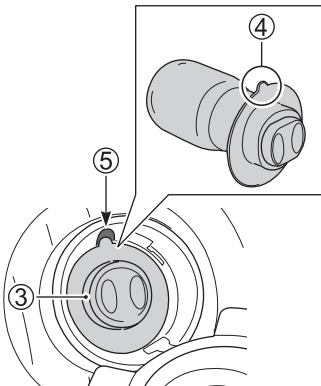

3. Pull out the bulb ③.
4. Fit the new bulb.
5. To reinstall the headlight, reverse the sequence described above.

## ***NOTICE***

The headlight bulb's life may be shortened by oil from your fingers if you touch it.

When replacing the headlight bulb, be careful not to touch the glass. Grasp the new bulb with a clean cloth.

*NOTE: Fit the bulb projection ④ to the bulb holder groove ⑤.*

## Front turn signal light

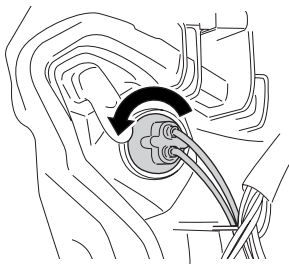

1. Turn the socket counterclockwise and remove it.

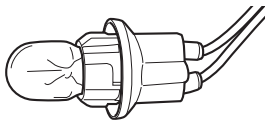

2. Pull off the bulb from the socket.

## Position light

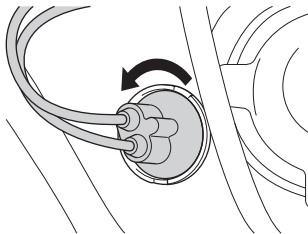

1. Turn the socket counterclockwise and remove it.

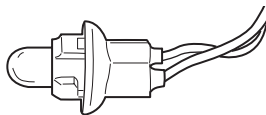

2. Pull off the bulb from the socket.

## HEADLIGHT BEAM ADJUSTMENT

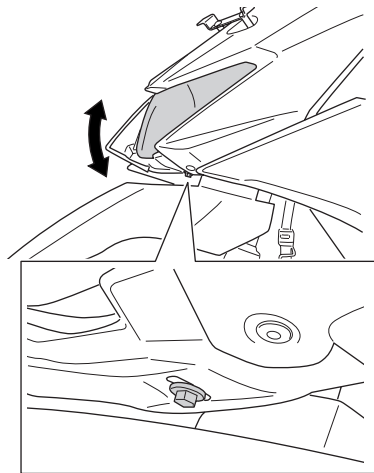

The headlight beam can be adjusted up and down if necessary. Loosen the headlight adjustment bolt, and move the headlight up or down as required.

## REAR TURN SIGNAL LIGHT/ BRAKE LIGHT/TAILLIGHT

To replace the brake light/taillight bulb, and rear turn signal light bulb, follow the procedure below:

### Rear turn signal light

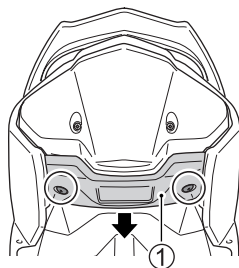

1. Remove the screws and take off the under frame cover ① backward.

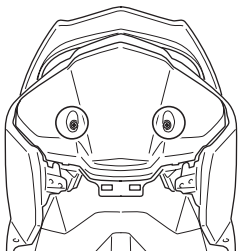

2. Remove the screws.

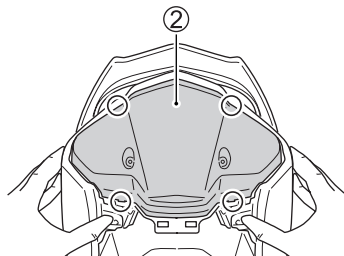

3. Unhook the hooks and take off the lens ②. Widen the covers when removing and replacing the lens to avoid scratching on the lens.

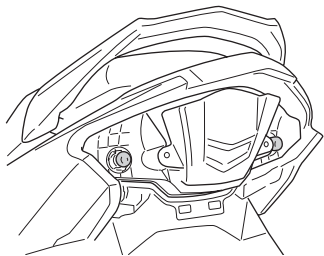

4. Pull off the bulb from the socket.

## Brake light/Taillight

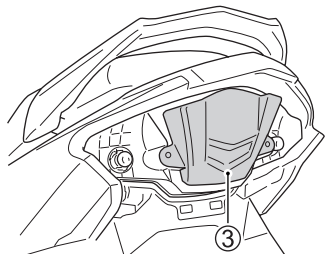

5. Take off the lens ③.

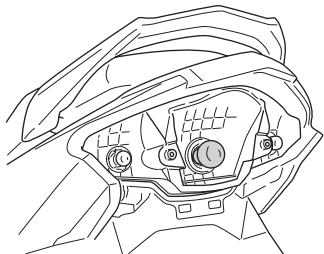

6. Push in on the burned-out bulb, turn it to the left, and pull it out.
7. To fit the replacement bulb, push it in and turn it to the right while pushing.

## ***NOTICE***

**Overtightening the screws when reinstalling the lens may cause the lens to crack.**

**Tighten the screws only until they are snug.**



## FUSE

If something electrical on your motorcycle stops working, the first thing you should check for is a blown fuse. The electrical circuits on the motorcycle are protected from overload by fuses in the circuits.

If a blown fuse is found, then the electrical problem must be inspected and repaired before replacing the blown fuse with a new fuse. Consult your Suzuki dealer for the electrical system check and repair.

## WARNING

**Replacing a fuse with a fuse that has an incorrect amperage rating or substitute, e.g. aluminum foil or wire, may cause serious damage to the electrical system and possibly fire. Always replace a blown fuse with a fuse of the same amperage rating.**

**If the new fuse blows in a short time, the electrical problem may not be fixed. Have your motorcycle inspected immediately by your Suzuki dealer.**

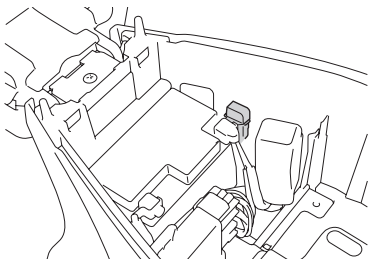

The fuse is located beside the battery. The 15A fuse is equipped. It is designed to open when a circuit overload exists in individual electrical system circuits. If any electrical system fails to operate, then the fuse must be checked. A 15A spare fuse is attached to the fuse case.

## CATALYTIC CONVERTER

The purpose of the catalytic converter is to minimize the amount of harmful pollutants in your motorcycle's exhaust. Use of leaded fuel in motorcycles equipped with catalytic converters is prohibited because lead deactivates the pollutant-reducing components of the catalyst system.

The converter is designed to last the life of the motorcycle under normal usage and when unleaded fuel is used. Not special maintenance is required on the converter. However, it is very important to keep the engine properly tuned. Engine misfiring, which can result from an improperly tuned engine, may cause overheating of the catalyst. This may result in permanent heat damage to the catalyst and other motorcycle components.

## **WARNING**

If you park or operate the motorcycle in areas where there are combustible materials such as dry grass or leaves, these materials may come in contact with the catalytic converter or other hot exhaust components. This can cause a fire.

Avoid parking or operating your motorcycle in areas with any combustible materials.

## **NOTICE**

Improper motorcycle operation can cause catalyst or other motorcycle damage.

To avoid damage to the catalyst or other related components, you should take the following precautions:

- Maintain the engine in the proper operating condition.
- In the event of an engine malfunction, particularly one involving engine misfire or other apparent performance loss, stop riding the motorcycle and turn off the engine and have the motorcycle serviced promptly.
- Do not shut off the engine or interrupt the ignition when the motorcycle is in motion.
- Do not idle the motorcycle for prolonged periods if idling seems rough or there are other malfunctions.
- Do not allow the fuel tank to get near the empty level.

# TROUBLESHOOTING

---

IGNITION SYSTEM CHECK .....	7-2
FUEL SUPPLY CHECK .....	7-3
ENGINE STALLING .....	7-3

## TROUBLESHOOTING

This troubleshooting guide is provided to help you find the cause of some common complaints.

### ***NOTICE***

**Improper repairs or adjustments may damage the motorcycle instead of fixing it. Such damage may not be covered under warranty.**

**If you are not sure about the proper action, consult your Suzuki dealer about the problem.**

**COMPLAINT:** Engine is hard to start or does not start at all.

## IGNITION SYSTEM CHECK

1. Remove the spark plug and reattach it to the spark plug cap.

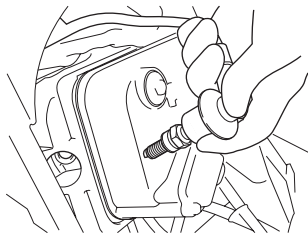

2. While holding the spark plug firmly against the engine, crank the engine with the ignition switch in the "ON" position. If the ignition system is operating properly, a blue spark should jump across the spark plug gap. If there is no spark, consult your Suzuki dealer for repairs.

## **WARNING**

**Performing the spark test improperly can be hazardous. You could get a high voltage electrical shock if you are not familiar with this procedure.**

**Do not perform this check if you are not familiar with the procedure. Do not point the spark plug near the spark plug hole during this test. Do not perform this test if you have a heart condition or wear a pacemaker.**

### **FUEL SUPPLY CHECK**

If the malfunction indicator light comes on, showing signs of trouble in the fuel injection system, take your machine to an authorized Suzuki dealer. Refer to the “INSTRUMENT PANEL” section for an explanation of malfunction indicator light.

### **ENGINE STALLING**

1. Make sure there is enough fuel in the fuel tank.
2. If the malfunction indicator light comes on, showing signs of trouble in the fuel injection system, take your machine to an authorized Suzuki dealer. Refer to the “INSTRUMENT PANEL” section for an explanation of malfunction indicator light.
3. Check the ignition system for intermittent spark.
4. Check the idle speed. The correct idle speed is 1400 – 1600 r/min.



# STORAGE PROCEDURE AND MOTORCYCLE CLEANING

---

STORAGE PROCEDURE .....	8-2
PROCEDURE FOR RETURNING TO SERVICE .....	8-3
CORROSION PREVENTION .....	8-4
MOTORCYCLE CLEANING .....	8-5
INSPECTION AFTER CLEANING .....	8-9



## STORAGE PROCEDURE AND MOTORCYCLE CLEANING

### STORAGE PROCEDURE

If the motorcycle is to be left unused for an extended period of time for winter storage or any other reason, the machine needs special servicing requiring appropriate materials, equipment and skill. For this reason, Suzuki recommends that you trust this maintenance work to your Suzuki dealer. If you need to service the motorcycle for storage yourself, follow the general guidelines below.

### MOTORCYCLE

Clean the entire motorcycle. Place the motorcycle on the center stand on a firm, flat surface where it will not fall over. Turn the handlebars all the way to the left and lock the steering, and remove the ignition key.

### FUEL

1. Fill the fuel tank to the top with fuel mixed with the amount of gasoline stabilizer recommended by the stabilizer manufacturer.
2. Run the engine for a few minutes until the stabilized gasoline fills the fuel injection system.

## **BATTERY**

1. Remove the battery from the motorcycle by referring to the BATTERY section.
2. Clean the outside of the battery with a mild detergent and remove any corrosion from the terminals and wiring harness connections.
3. Store the battery in a room above freezing.

## **TIRES**

Inflate the tires to the normal specifications.

## **EXTERNAL**

- Spray all vinyl and rubber parts with rubber preservative.
- Spray the unpainted surfaces with rust preventative.
- Coat the painted surfaces with car wax.

## **PROCEDURE DURING STORAGE**

Once a month, recharge the battery by referring to the BATTERY section. If you cannot charge the battery, consult your authorized Suzuki dealer.

## **PROCEDURE FOR RETURNING TO SERVICE**

- Clean the entire motorcycle.
- Reinstall the battery by referring to the BATTERY section.
- Adjust the pressure of tires as described in the TIRE section.
- Lubricate all places as instructed in this manual.
- Do the “INSPECTION BEFORE RIDING” as listed in this manual.

## **CORROSION PREVENTION**

It is important to take good care of your motorcycle to protect it from corrosion and keep it looking new for years to come.

### **Important Information About Corrosion**

Common causes of corrosion

- Accumulation of road salt, dirt, moisture, or chemicals in hard-to-reach areas.
- Chipping, scratches, and any damage to treated or painted metal surfaces resulting from minor accidents or impacts from stones and gravel.

Road salt, sea air, industrial pollution, and high humidity will all contribute to corrosion.

### **How to Help Prevent Corrosion**

- Wash your motorcycle frequently, at least once a month. Keep your motorcycle as clean and dry as possible.
- Remove foreign material deposits. Foreign material such as road salt, chemicals, road oil or tar, tree sap, bird droppings and industrial fall-out may damage your motorcycle's finish. Remove these types of deposits as quickly as possible. If these deposits are difficult to wash off, an additional cleaner may be required. Follow the manufacturer's directions when using these special cleaners.
- Repair finish damage as soon as possible. Carefully examine your motorcycle for damage to the painted surfaces. Should you find any chips or scratches in the paint, touch them up immediately to prevent corrosion from starting. If the chips or scratches have gone through to the bare metal, have a Suzuki dealer make the repair.

- Store your motorcycle in a dry, well-ventilated area. If you often wash your motorcycle in the garage or if you frequently park it inside when wet, your garage may be damp. The high humidity may cause or accelerate corrosion. A wet motorcycle may corrode even in a heated garage if the ventilation is poor.
- Cover your motorcycle. Exposure to mid-day sun can cause the colors in paint, plastic parts, and instrument faces to fade. Covering your motorcycle with a high-quality, “breathable” motorcycle cover can help protect the finish from the harmful UV rays in sunlight, and can reduce the amount of dust and air pollution reaching the surface. Your Suzuki dealer can help you select the right cover for your motorcycle.

## **MOTORCYCLE CLEANING**

### **WASHING THE MOTORCYCLE**

When washing the motorcycle, follow the instructions below:

1. Remove dirt and mud from the motorcycle with cool running water. You may use a soft sponge or brush. Do not use hard materials which can scratch the paint.
2. Wash the entire motorcycle with a mild detergent or car wash soap using a sponge or soft cloth. The sponge or cloth should be frequently soaked in the soap solution.

*NOTE: Clean the motorcycle with cool water immediately after riding on road salt or riding along the coast. Be sure to use cool water because warm water can hasten corrosion.*

*NOTE: Avoid spraying or allowing water to flow over the following places:*

- *Ignition switch*
- *Spark plug*
- *Fuel tank cap*
- *Fuel injection system*
- *Brake master cylinder*
- *Throttle cable boots*

## **NOTICE**

**High pressure washers such as those found at coin-operated car washes have enough pressure to damage the parts of your motorcycle. It may cause rust, corrosion and increase wear. Parts cleaner can also damage motorcycle parts.**

**Do not use high pressure washers to clean your motorcycle. Do not use parts cleaner on throttle body and fuel injection sensors.**

3. Once the dirt has been completely removed, rinse off the detergent with running water.
4. After rinsing, wipe off the motorcycle with a wet chamois or cloth and allow it to dry in the shade.
5. Check carefully for damage to painted surfaces. If there is any damage, obtain “touch-up” paint and “touch-up” the damage following the procedure below:
  - a. Clean all damaged spots and allow them to dry.
  - b. Stir the paint and “touch-up” the damaged spots lightly with a small brush.
  - c. Allow the paint to dry completely.

*NOTE: The headlight lens can be fogged after washing the motorcycle or riding in the rain. Headlight fogging will be cleared gradually when the headlight is turned on. When clearing the headlight lens fogging, run the engine to avoid battery discharge.*

## **NOTICE**

**Cleaning your motorcycle with any alkaline or strong acid cleaner, gasoline, brake fluid, or any other solvent will damage the motorcycle parts.**

**Clean only with soft cloth and warm water with mild detergent.**

## **PLASTIC PARTS**

Plastic parts such as headlight lens, speedometer display are easy to be damaged. When such part is cleaned, wash it using water after cleaning it using neutral detergent or soapy water, and wipe it with a soft cloth.

## **NOTICE**

**When any of the following substances is attached to the plastic part such as headlight lens, speedometer display, it might cause a scratch or damage to the part.**

- Wax compound
- Chemical supplies such as oil film removing agent or repellents
- Acidic or alkaline detergent
- Brake fluid, gasoline or organic solvent, etc.

## **WAXING THE MOTORCYCLE**

After washing the motorcycle, waxing and polishing are recommended to further protect and beautify the paint.

- Only use waxes and polishes of good quality.
- When using waxes and polishes, observe the precautions specified by the manufacturers.

## **SPECIAL CARE FOR MATTE FINISH PAINT**

Do not use polishing compounds or waxes that contain polishing compounds on surfaces which have a matte finish. The use of polishing compounds will change the appearance of the matte finish.

Solid type waxes may be difficult to remove from surfaces with a matte finish.

Friction while riding, excessive rubbing or polishing of a surface with a matte finish will change its appearance.

## **INSPECTION AFTER CLEANING**

For extended life of your motorcycle, lubricate it according to the “LUBRICATION POINTS” section.

### **WARNING**

**Operating the motorcycle with wet brakes can be hazardous. Wet brakes may not provide as much stopping power as dry brakes.**

**This could lead to an accident. Test your brakes after washing the motorcycle, while riding at slow speed. If necessary, apply the brakes several times to let friction dry out the linings.**

Follow the procedures in the “INSPECTION BEFORE RIDING” section to check your motorcycle for any problems that may have arisen during your last ride.



# SPECIFICATIONS

## DIMENSIONS AND CURB MASS

Overall length .....	1890 mm
Overall width.....	765 mm..... UX110NER
	675 mm..... UX110NE/NZ
Overall height .....	1055 mm..... UX110NER
	1045 mm..... UX110NE/NZ
Wheelbase .....	1260 mm
Ground clearance.....	150 mm
Curb mass .....	94 kg..... UX110NER
	93 kg..... UX110NE/NZ

## ENGINE

Type .....	4-stroke, air-cooled, SOHC
Number of cylinders .....	1
Bore.....	51.0 mm
Stroke.....	55.2 mm
Displacement.....	113 cm <sup>3</sup>
Fuel system .....	Fuel injection
Air cleaner .....	Paper element
Starter system .....	Electric and primary kick
Lubrication system .....	Wet sump

## **DRIVE TRAIN**

Clutch .....	Dry shoe, automatic, centrifugal type
Transmission .....	CVT
Gearshift pattern.....	Automatic
Automatic transmission ratio .....	2.655 – 0.806 (Variable)
Final reduction ratio.....	9.942 (44/16 × 47/13)
Drive system.....	V-belt drive

## **CHASSIS**

Front suspension.....	Telescopic, coil spring, oil damped
Rear suspension .....	Swingarm type, coil spring, oil damped
Front fork stroke .....	90 mm
Turning radius .....	2.0 m
Front brake .....	Disk brake
Rear brake.....	Drum brake
Front tire size.....	80/90-14M/C 40P, tubeless
Rear tire size .....	90/90-14M/C 46P, tubeless

## ELECTRICAL

Ignition type .....	Electronic ignition (Transistorized)
Spark plug .....	NGK CPR7EA-9 or DENSO U22EPR9
Battery .....	12V 10.8 kC(3.0 Ah)/10HR
Generator .....	Single-phase A.C. generator
Fuse .....	15A
Headlight .....	12V 32/32W
Brake light/Taillight .....	12V 18/5W
Position light .....	12V 3.4W
Front turn signal light .....	12V 10W × 2
Rear turn signal light .....	12V 10W × 2
High beam indicator light .....	LED..... UX110NER 12V 1.7W..... UX110NE/NZ
Turn signal indicator light .....	LED..... UX110NER 12V 1.7W..... UX110NE/NZ
Speedometer illumination light .....	LED..... UX110NER 12V 1.7W..... UX110NE/NZ
Malfunction indicator light .....	LED..... UX110NER 12V 1.7W..... UX110NE/NZ

## CAPACITIES

Fuel tank.....	3.6 L
Engine oil, oil change .....	650 ml
With filter change .....	700 ml
Overhaul .....	800 ml
Final gearbox oil, oil change.....	90 ml
Overhaul .....	100 ml



# Warranty System



## WARRANTY COVERAGE

FOR ALL MODELS

24 months or 20,000km  
whichever comes first

## EXPENDABLE PARTS NOT COVERED BY WARRANTY

- Spark plugs
- Lamp bulbs
- Fuses
- Rubber parts except engine oil seals
- Bolts, nuts, washers
- Brake / clutch linings
- Cables
- Gaskets
- Tires and inner tubes
- Mags
- Spokes
- Sprockets (Engine and wheel)
- Drive chain / V-belt

## CONDITIONS NOT COVERED BY WARRANTY

- Units that have not undergone required periodic inspection.
- Units serviced by mechanics not authorized by Suzuki.
- Units damaged by use of parts other than Suzuki Genuine Parts.
- Damages caused by users negligence or abuse.
- Delivery or transport problems.
- Changes or alterations in the unit not recommended by Suzuki.
- Accidents, collisions, over-revolution of engine, racing...
- Use of fuel and oil not recommended by Suzuki.
- Trouble caused by breaking a seal or disassembling any unremovable parts such as ECM, CDI unit, switches, speedometer, oil pump, fuel pump, etc.
- Trouble caused by inappropriate care (Rusting, fading of color, natural deterioration, etc.)

## SERVICE RECORD

Reliability and performance depend on the special care and maintenance of your motorcycle. Visit your dealers for Periodic Maintenance Service when your motorcycle has reached the specified number of month/s or kilometer reading (whichever comes first) as shown below.

Owner's Name				Dealer Name	
Address				Address	
Model		Color		Date Purchased	
Eng No.				Frame No.	

1st Month (1,000 km) Service						
Service Date			Km Reading		JO No.	
Servicing Dealer / Address						
Mechanic Name / Signature			Customer Name / Signature			
Replaced Oil?	<input type="checkbox"/> YES	<input type="checkbox"/> NO	Replaced Oil filter?	<input type="checkbox"/> YES	<input type="checkbox"/> NO	If YES what oil brand?

**4th Month (4,000 km) Service**

Service Date		Km Reading		JO No.	
Servicing Dealer / Address					
Mechanic Name / Signature		Customer Name / Signature			
Replaced Oil?	<input type="checkbox"/> YES <input type="checkbox"/> NO	Replaced Oil filter?	<input type="checkbox"/> YES <input type="checkbox"/> NO	If YES what oil brand?	

**8th Month (8,000 km) Service**

Service Date		Km Reading		JO No.	
Servicing Dealer / Address					
Mechanic Name / Signature		Customer Name / Signature			
Replaced Oil?	<input type="checkbox"/> YES <input type="checkbox"/> NO	Replaced Oil filter?	<input type="checkbox"/> YES <input type="checkbox"/> NO	If YES what oil brand?	

**12th Month (12,000 km) Service**

Service Date		Km Reading		JO No.	
Servicing Dealer / Address					
Mechanic Name / Signature		Customer Name / Signature			
Replaced Oil?	<input type="checkbox"/> YES <input type="checkbox"/> NO	Replaced Oil filter?	<input type="checkbox"/> YES <input type="checkbox"/> NO	If YES what oil brand?	

**16th Month (16,000 km) Service**

Service Date		Km Reading		JO No.	
Servicing Dealer / Address					
Mechanic Name / Signature		Customer Name / Signature			
Replaced Oil?	<input type="checkbox"/> YES <input type="checkbox"/> NO	Replaced Oil filter?	<input type="checkbox"/> YES <input type="checkbox"/> NO	If YES what oil brand?	

**24th Month (20,000 km) Service**

Service Date		Km Reading		JO No.	
Servicing Dealer / Address					
Mechanic Name / Signature		Customer Name / Signature			
Replaced Oil?	<input type="checkbox"/> YES <input type="checkbox"/> NO	Replaced Oil filter?	<input type="checkbox"/> YES <input type="checkbox"/> NO	If YES what oil brand?	





# INDEX

---

- A**  
ACCESSORY USE AND MOTORCYCLE  
LOADING..... 1-2  
AIR CLEANER.....6-18  
AVOID CONSTANT LOW SPEED ..... 4-3
- B**  
BATTERY ..... 6-9  
BRAKES ..... 6-36  
BREAK-IN (RUNNING-IN)..... 4-2  
BREAKING IN THE NEW TIRES ..... 4-3
- C**  
CATALYTIC CONVERTER ..... 6-62  
COOLING FAN FILTER..... 6-26  
CORROSION PREVENTION ..... 8-4
- E**  
ENGINE OIL ..... 6-28  
ENGINE OIL AND GEAR OIL..... 3-4  
ENGINE STALLING..... 7-3
- F**  
FRONT HOOK..... 2-35  
FRONT RACKS..... 2-36  
FUEL ..... 3-2  
FUEL HOSE ..... 6-24  
FUEL SUPPLY CHECK..... 7-3  
FUEL TANK CAP ..... 2-32  
FUSE ..... 6-61
- G**  
GEAR OIL..... 6-35
- I**  
IDLE SPEED ADJUSTMENT ..... 6-22  
IGNITION SWITCH ..... 2-14  
IGNITION SYSTEM CHECK ..... 7-2  
INSPECTION AFTER CLEANING ..... 8-9  
INSPECTION BEFORE RIDING ..... 4-4  
INSTRUMENT PANEL (UX110NER) ..... 2-17  
INSTRUMENT PANEL (UX110NE/NZ).... 2-26

---

## **K**

- KEY.....2-14
- KICK STARTER LEVER.....2-33

## **L**

- LABELS ..... 1-8
- LEFT HANDLEBAR.....2-28
- LIGHT BULB REPLACEMENT .....6-49
- LOCATION OF PARTS .....2-2
- LUBRICATION POINTS .....6-6

## **M**

- MAINTENANCE SCHEDULE .....6-2
- MAXIMUM THROTTLE OPERATION  
RECOMMENDATION.....4-2
- MODIFICATION.....1-5
- MOTORCYCLE CLEANING .....8-5

## **O**

- OBSERVE YOUR FIRST AND MOST  
CRITICAL SERVICE ..... 4-4
- OXYGENATED FUEL  
RECOMMENDATION.....3-3

## **P**

- PROCEDURE FOR RETURNING TO  
SERVICE.....8-3

## **R**

- RIGHT HANDLEBAR .....2-30
- 

---

## S

SAFE RIDING RECOMMENDATION FOR MOTORCYCLE RIDERS.....	1-5
SEAT LOCK AND HELMET HOLDERS.....	2-34
SERIAL NUMBER LOCATION.....	1-9
SIDE STAND/IGNITION INTERLOCK SYSTEM.....	6-49
SPARK PLUG.....	6-13
STANDS.....	2-37
STARTING OFF.....	5-5
STARTING THE ENGINE.....	5-2
STOPPING AND PARKING.....	5-6
STORAGE PROCEDURE.....	8-2

## T

THROTTLE CABLE PLAY.....	6-23
TIRES.....	6-44
TOOLS.....	6-6
TRUNK.....	2-36

## V

VARY THE ENGINE SPEED.....	4-2
----------------------------	-----



**SUZUKI PHILIPPINES, INCORPORATED**

126 Progress Avenue, Carmelray Industrial Park 1,  
Carmelton, Canlubang, Calamba City 4028, Laguna

WEBSITE: <http://www.suzuki.com.ph>

**Part No. 99011C01K73L31R     December 2021**



Printed in the Philippines